

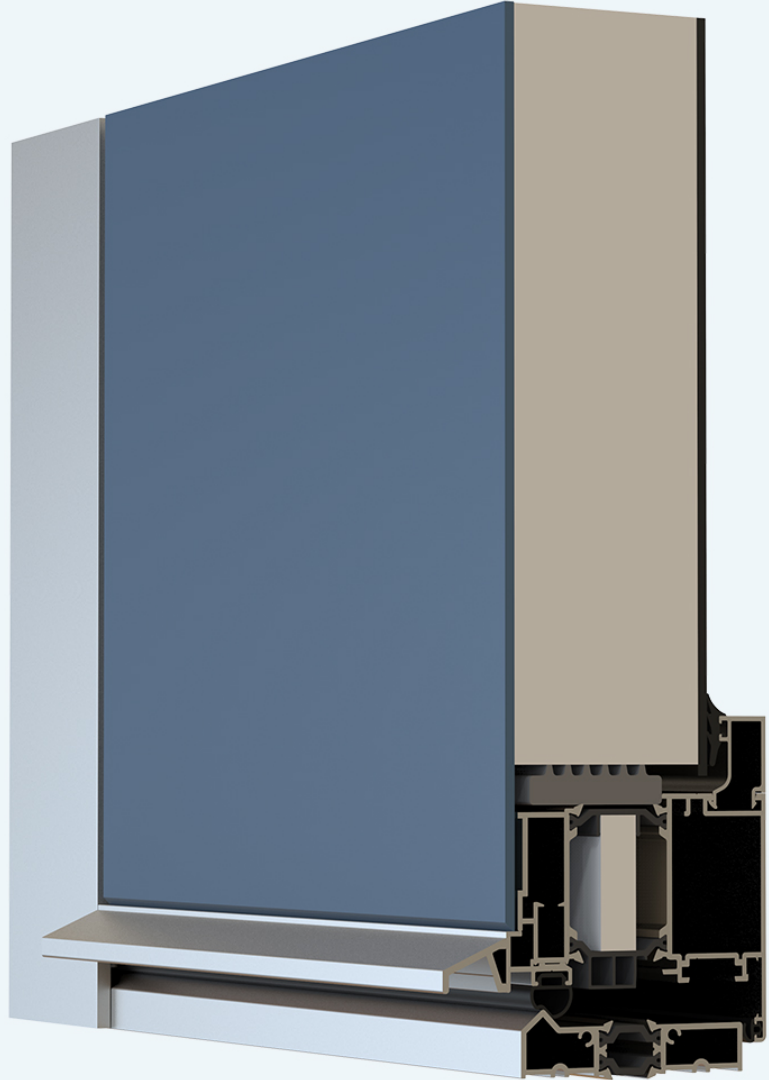

**EMERUS**

ALUMINIUM EXTRUSION



**PE85Ntt**







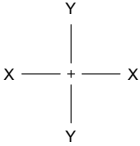

Ulazna vrata

**TEHNIČKI KATALOG**



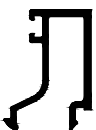



## PROFIL I

Kod Codice Code	Presjek Sezione Cross Section		Težina	Perimetar	Vidljiva	Jx	Wx	Jy	Wy	
			Peso Weight	Perimetro Perimeter	površina Sup. in Vista Exposed surface					
			Kg/m	mm	mm	cm <sup>4</sup>	cm <sup>4</sup>	cm <sup>4</sup>	cm <sup>4</sup>	
PE85202			0841	1.860	331.1	133.1	58.51	12.25	20.48	4.88
			0839							
PE85206			0843	1.967	345.1	147.1	65.19	13.72	29.49	6.49
			0842							
PE85242			0847	2.195	496.5	142.4	64.94	16.32	51.34	10.32
			0848							
PE85214			0845	2.010	363.5	140.0	66.14	15.32	35.64	8.26
			0846							
PE85235			0820	2.141	386.7	114.5	24.72	6.50	19.11	7.50
			0840							
PE85139			0806	1.607	370.5	114.5	49.8	11.5	12.5	3.54
			0625							
PE85241			0850	0.988	370.5	91.17	1.15	1.0	16.56	4.50
			0851							

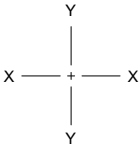
**PROFILI**

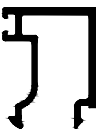
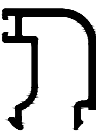

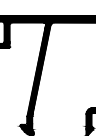
Kod Codice Code	Presjek Sezione Cross Section		Težina Peso Weight  Kg/m	Perimetar Perimetro Perimeter  mm	Vidljiva površina Sup. in Vista Exposed surface mm	Jx  cm <sup>4</sup>	Wx  cm <sup>4</sup>	Jy  cm <sup>4</sup>	Wy  cm <sup>4</sup>
PR50553			0.258	151.12	31.1				
PR50554			0.260	151.84	32.1				
PR50555			0.248	146.01	28.8				
PR50556			0.266	154.02	35.1				
PR50557			0.255	148.35	31.88				
PR50558			0.271	155.47	37.1				
PR50559			0.259	149.81	33.88				
PR50560			0.275	156.92	39.1				

**PROFILI**



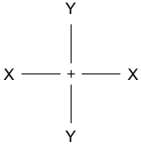
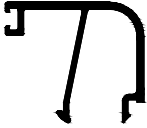
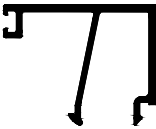
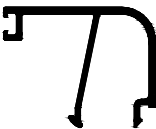
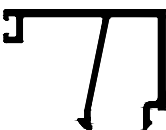
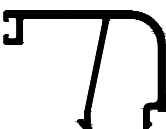

Kod Codice Code	Presjek Sezione Cross Section		Težina Peso Weight	Perimetar Perimetro Perimeter	Vidljiva površina Sup. in Vista Exposed surface mm	Jx	Wx	Jy	Wy
			Kg/m	mm	mm	cm <sup>4</sup>	cm <sup>4</sup>	cm <sup>4</sup>	cm <sup>4</sup>
PR50561			0.263	151.26	35.88				
PR50562			0.298	170.22	42.1				
PR50563			0.287	164.55	38.88				
PR50564			0.306	173.09	45.1				
PR50565			0.294	167.42	41.88				
PR50566			0.322	182.16	47.1				
PR50567			0.301	176.49	43.88				
PR50568			0.342	192.16	52.1				

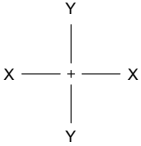

**PROFILI**

Kod Codice Code	Presjek Sezione Cross Section 	Težina Peso Weight <i>Kg/m</i>	Perimetar Perimetro Perimeter mm	Vidljiva površina Sup. in Vista Exposed surface mm	Jx <i>cm<sup>4</sup></i>	Wx <i>cm<sup>4</sup></i>	Jy <i>cm<sup>4</sup></i>	Wy <i>cm<sup>4</sup></i>
PR50569		0.330	176.49	48.88				
PR50570		0.354	198.16	55.1				
PR50571		0.341	192.49	51.88				
PR50572		0.362	202.16	57.1				
PR50573		0.350	196.49	53.88				
PR50574		0.211	104.50	26.60				
PR50576		0.218	103.56	27.10				

## PROFILI

Kod Codice Code	Presjek Sezione Cross Section		Težina Peso Weight  Kg/m	Perimetar Perimetro Perimeter  mm	Vidljiva površina Sup. in Vista Exposed surface mm	Jx  cm <sup>4</sup>	Wx  cm <sup>4</sup>	Jy  cm <sup>4</sup>	Wy  cm <sup>4</sup>
PR50550			0.158	49.06	14.5				
PR58538			0.206	105.3	20.9				
PR58543			0.211	80.3	28.0				

PROFILI OKVIRA

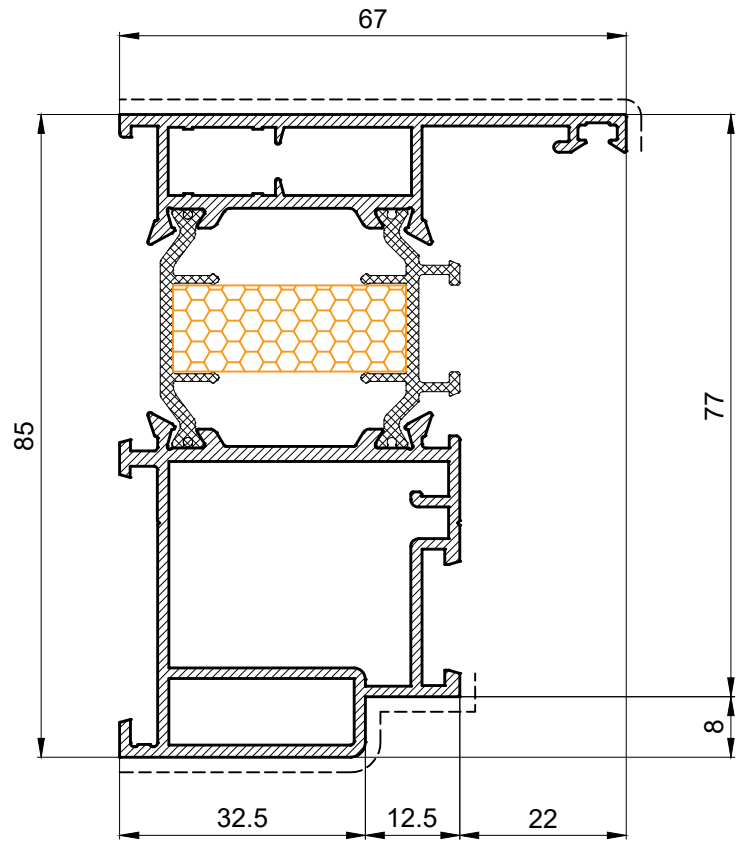

PE85202 1.860 Kg/m

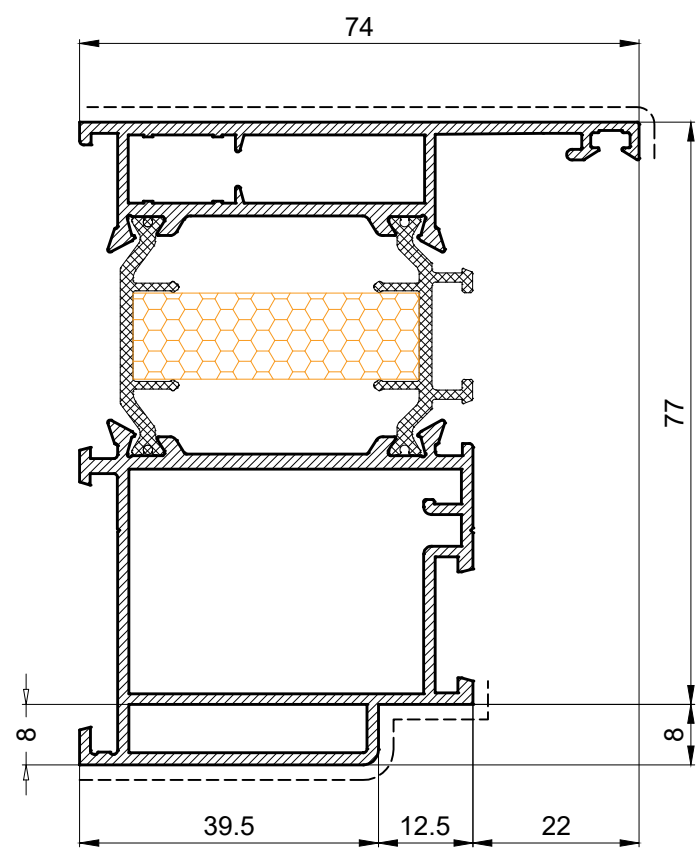

PE85206 1.967 Kg/m

PROFILI KRILA

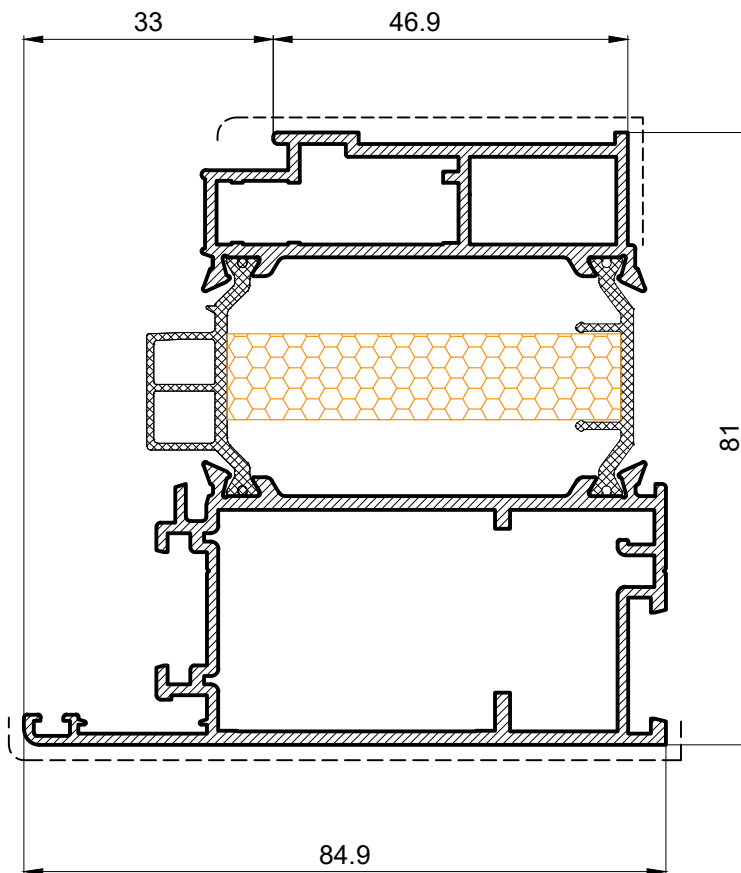

PE85242 2.195 Kg/m

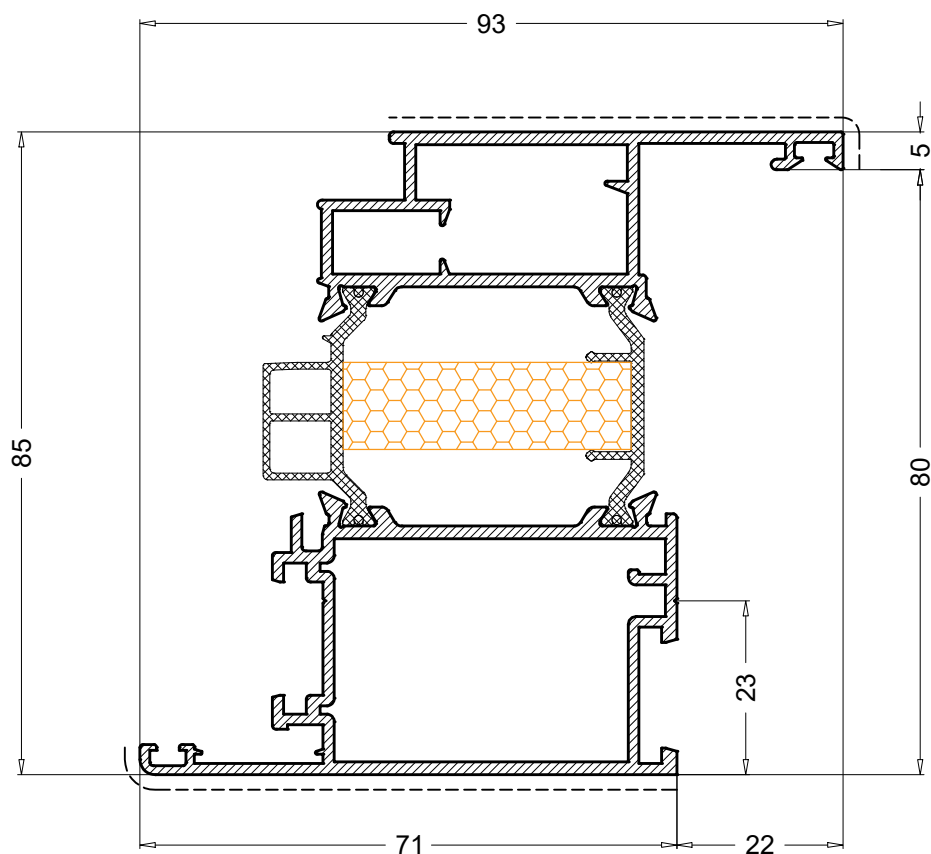

PE85214 2.046 Kg/m

PROFILI KRILA

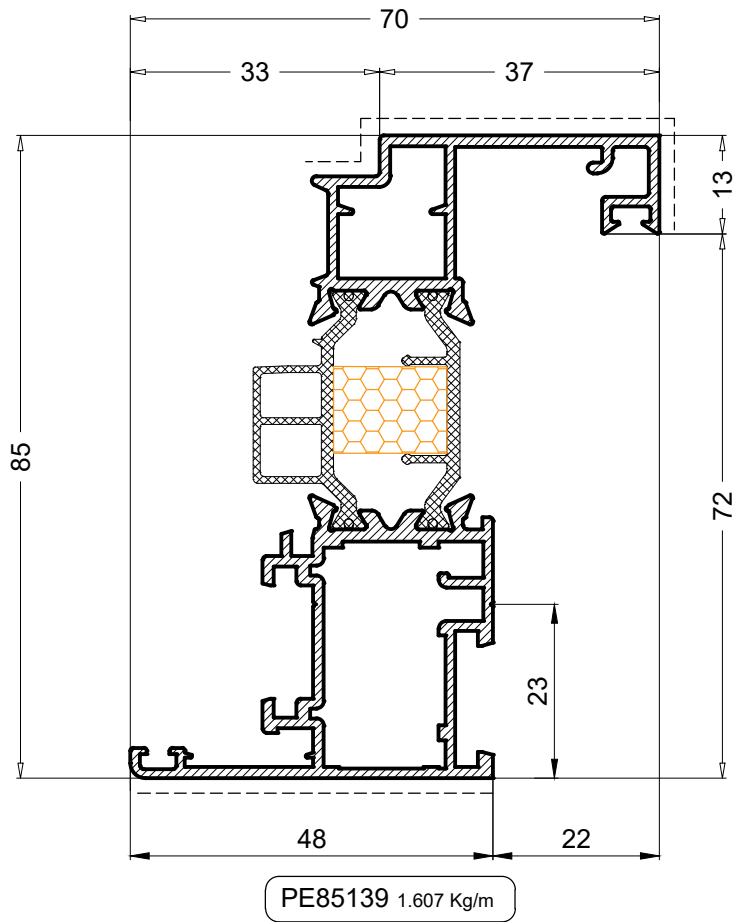

PROFILI PREČKE I PRAGA

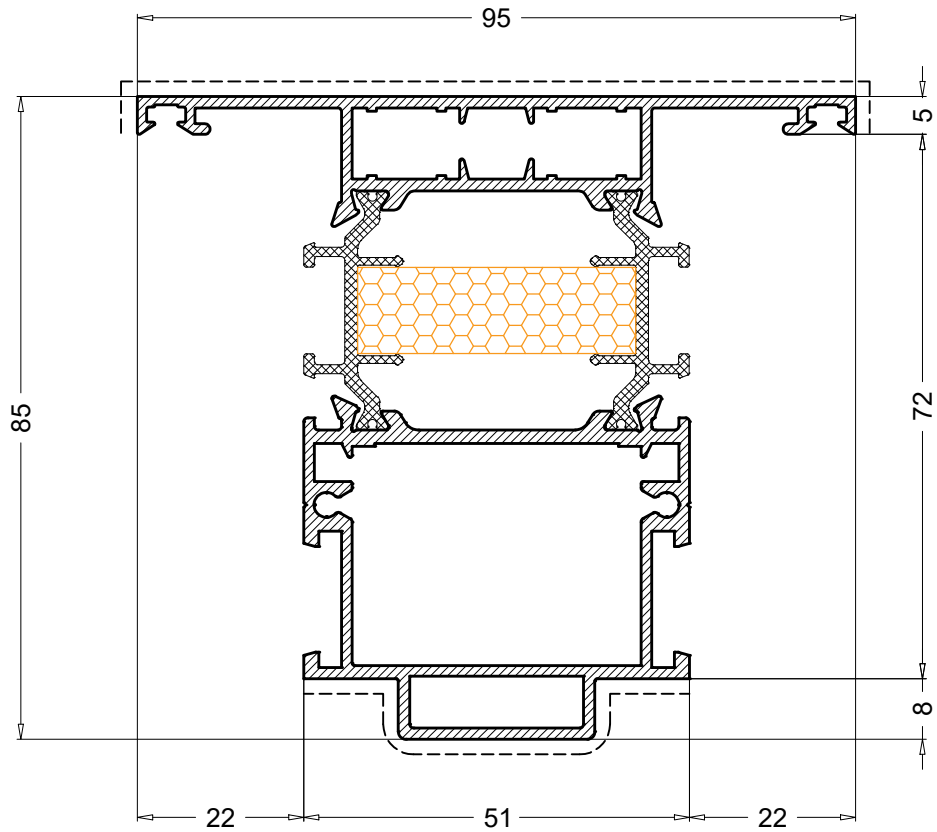

PE85235 2.142 Kg/m

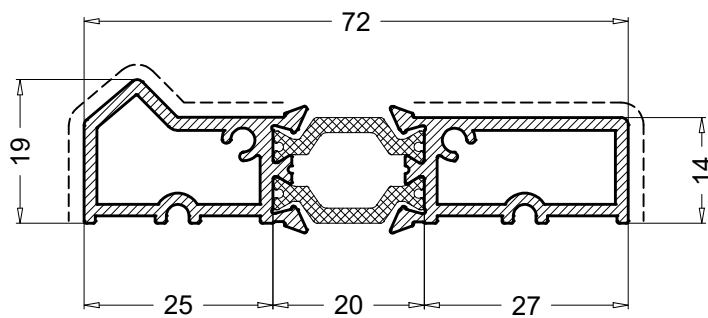

PE85241 0.988 Kg/m

DODATNI PROFILI

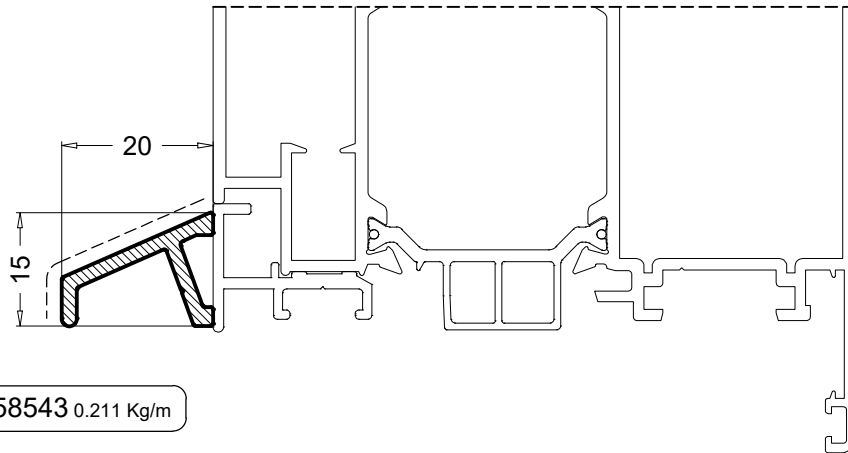

PR58543 0.211 Kg/m

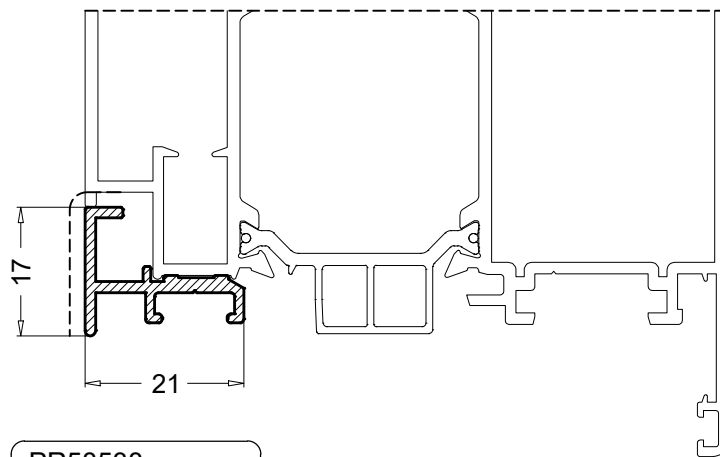

PR58538 0.206 Kg/m

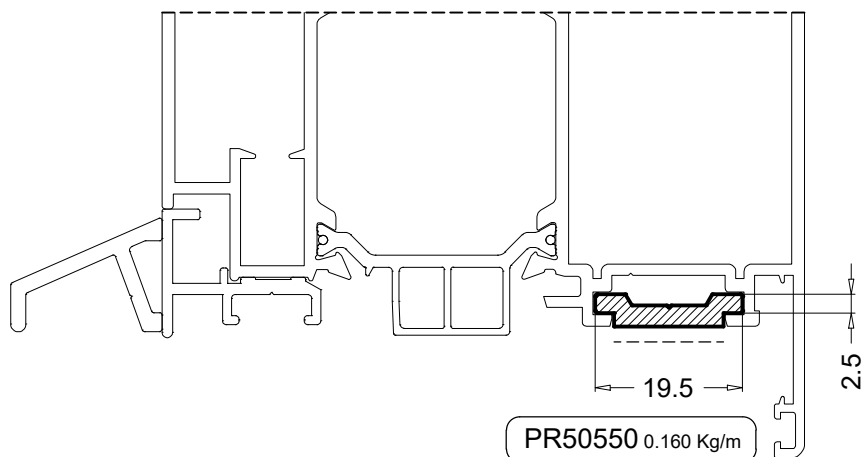

PR50550 0.160 Kg/m

**PROFILI LAJSNE**

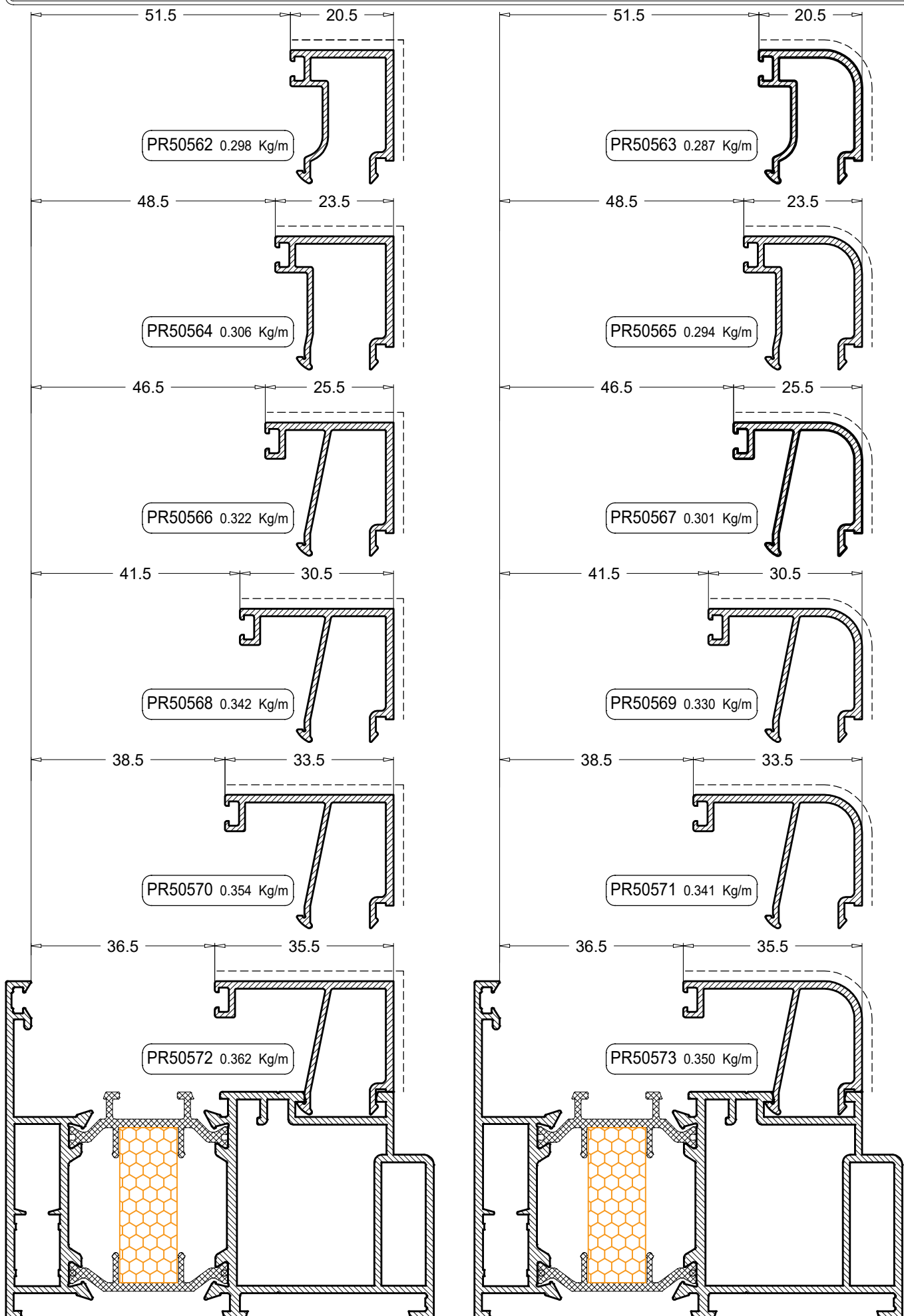



**PROFILI LAJSNE**

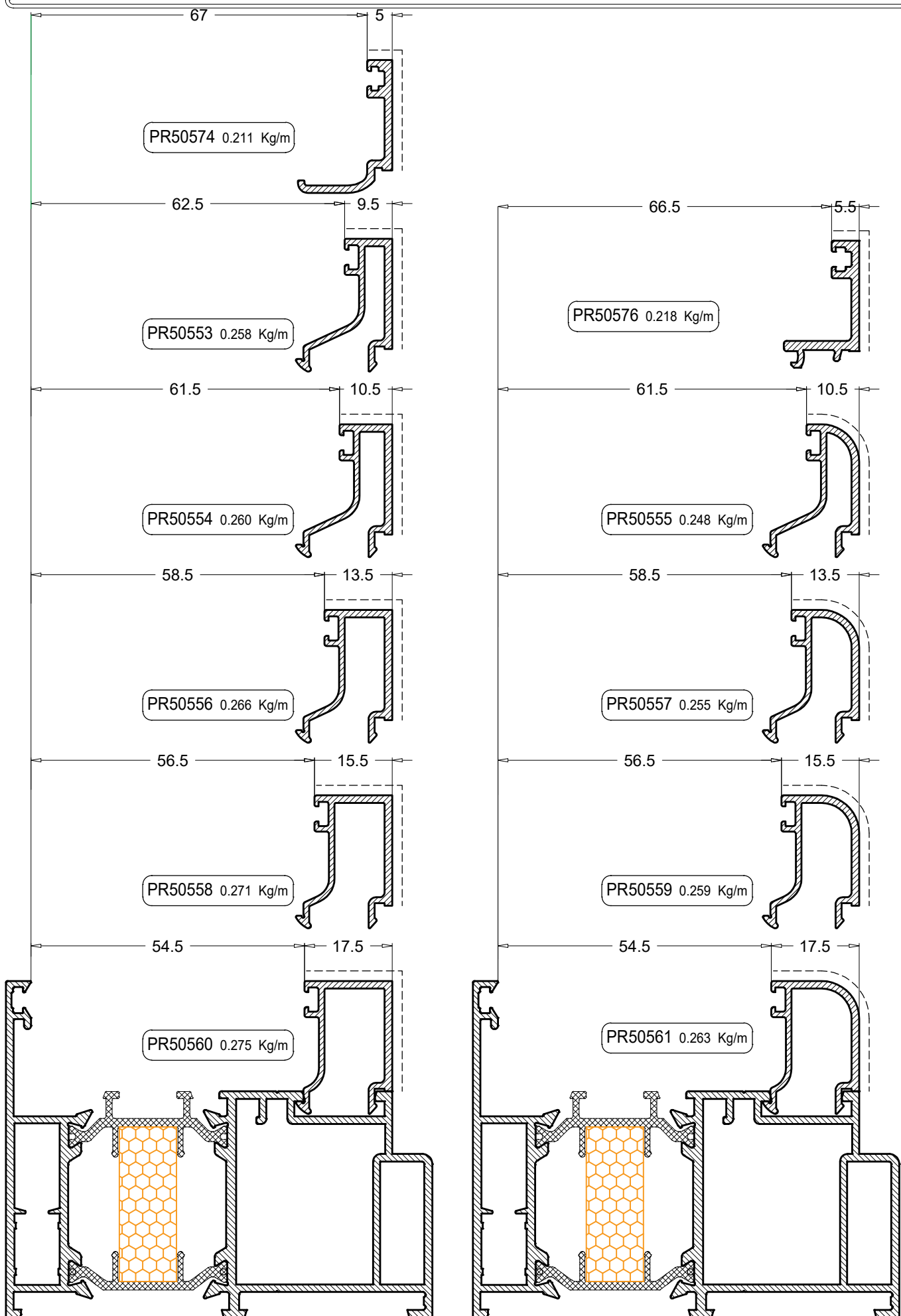

**PROFILI LAJSNE**

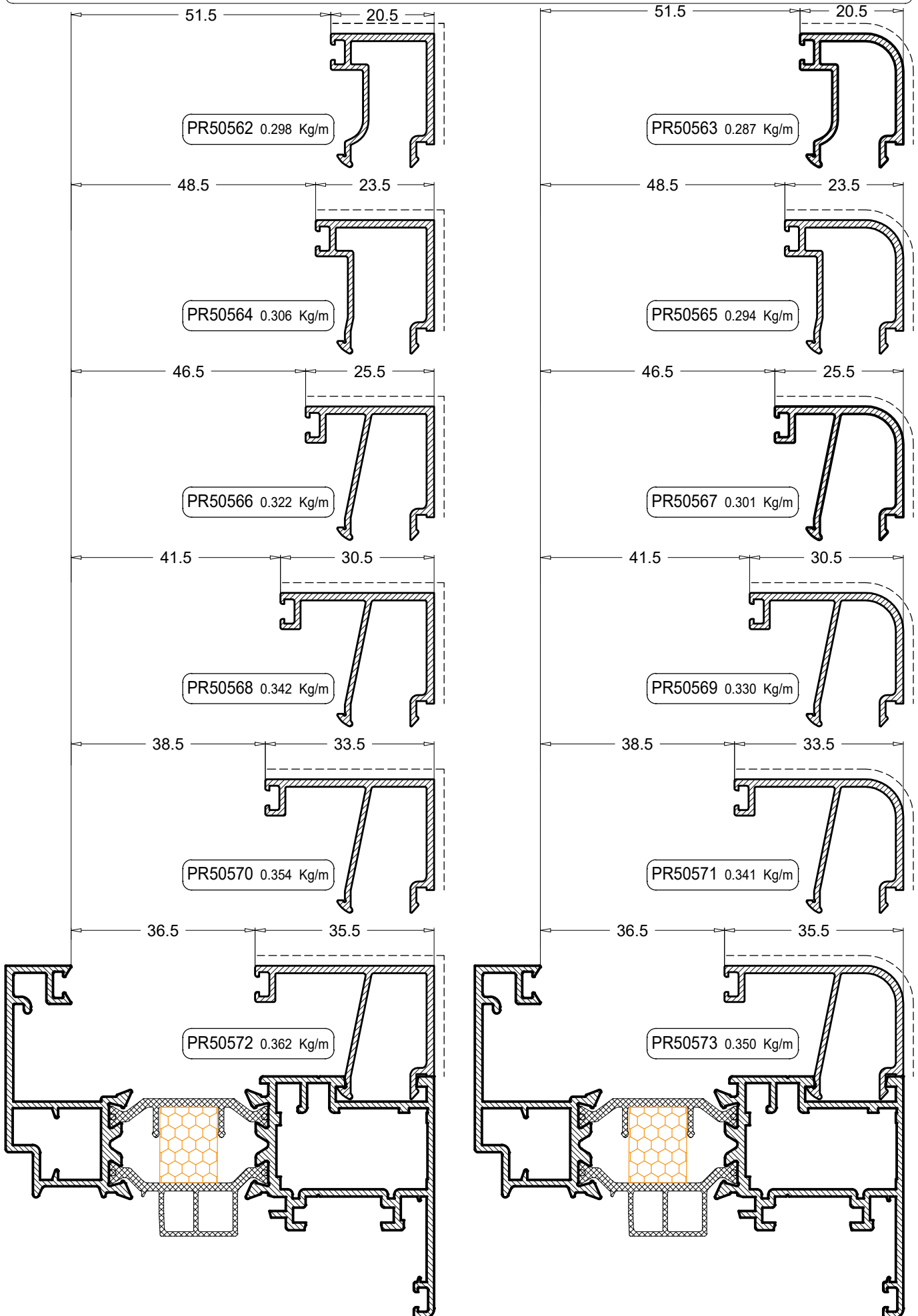

**PROFILI LAJSNE**

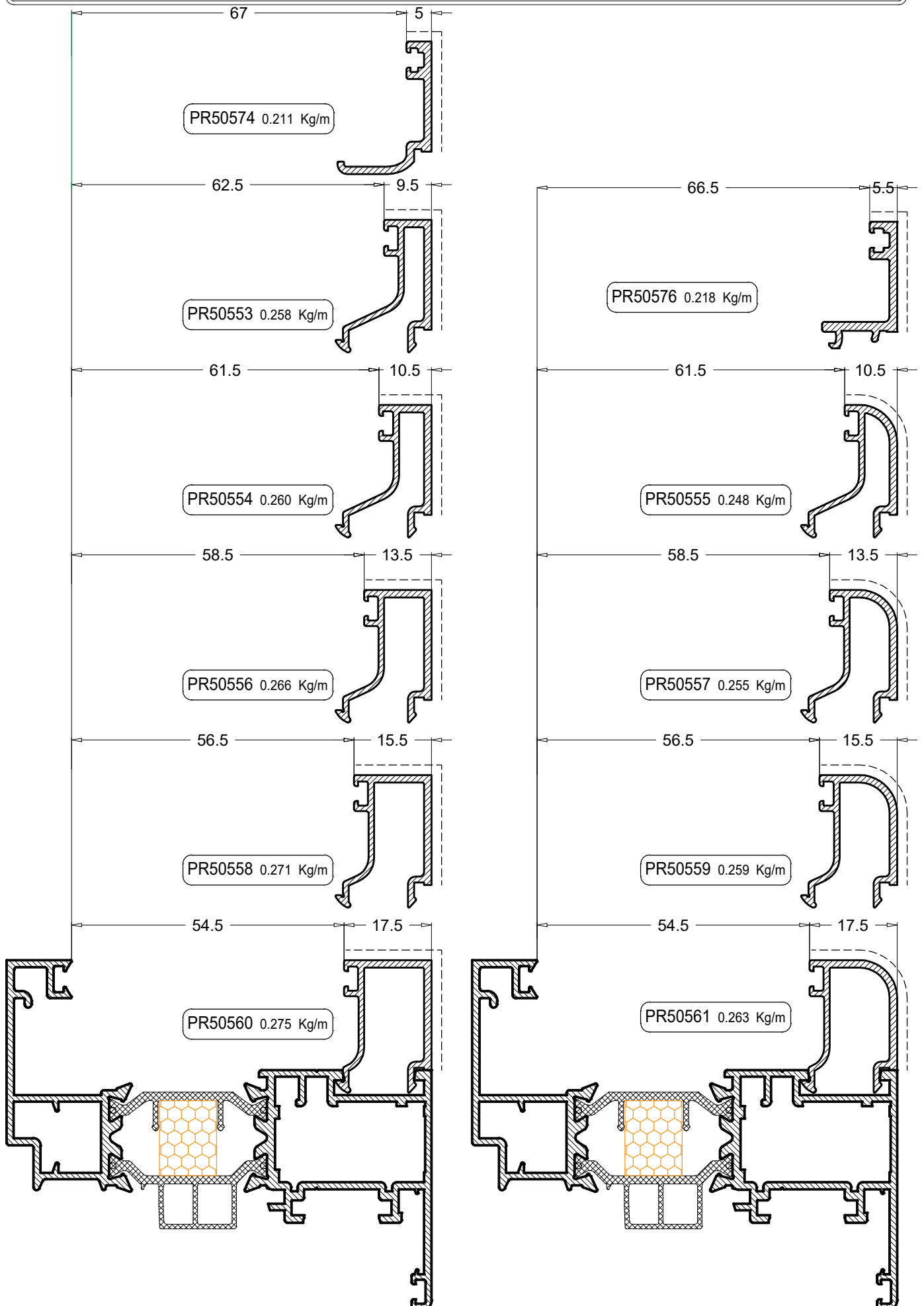

## PROFILI LAJSNE

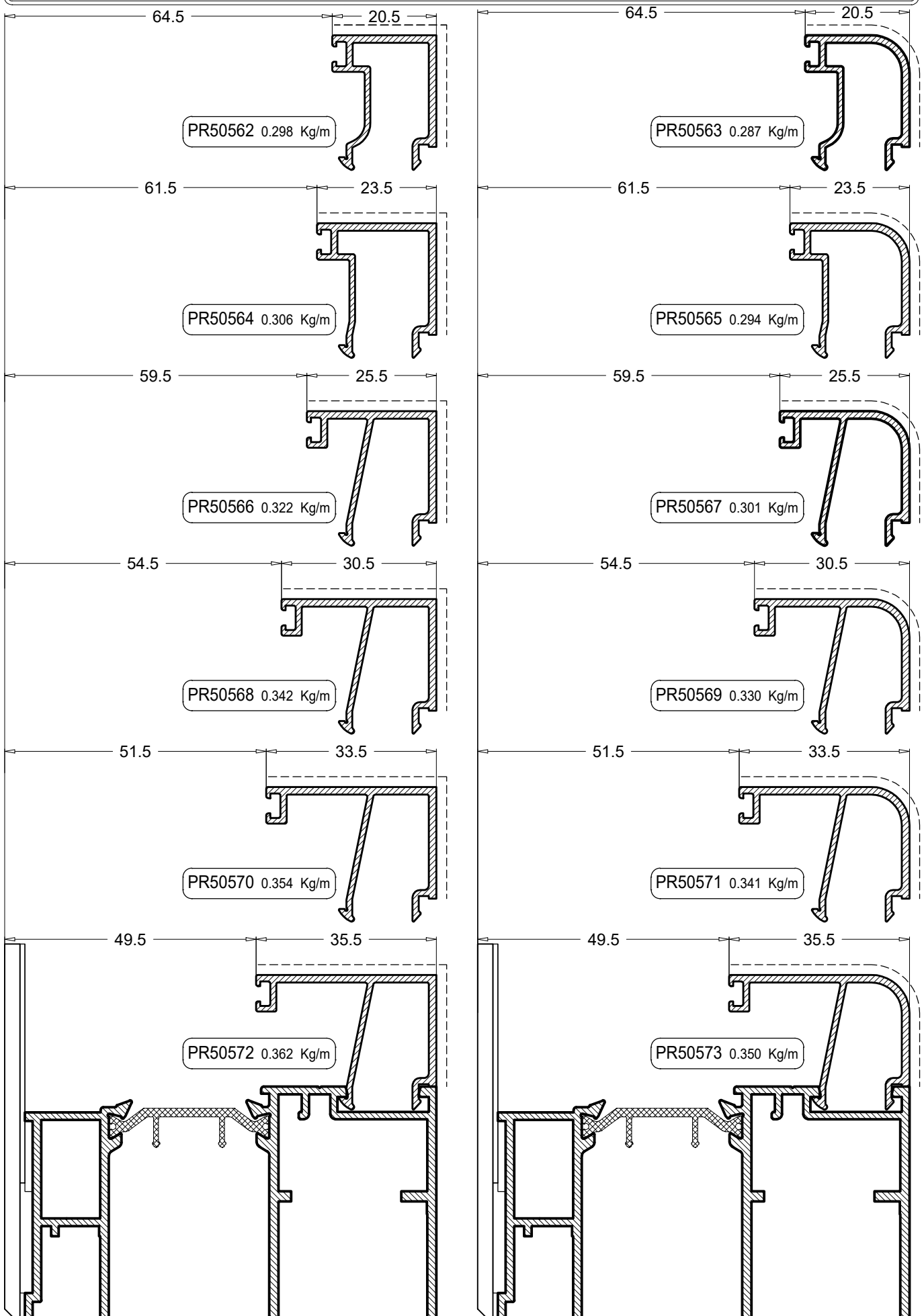

**PROFILI LAJSNE**

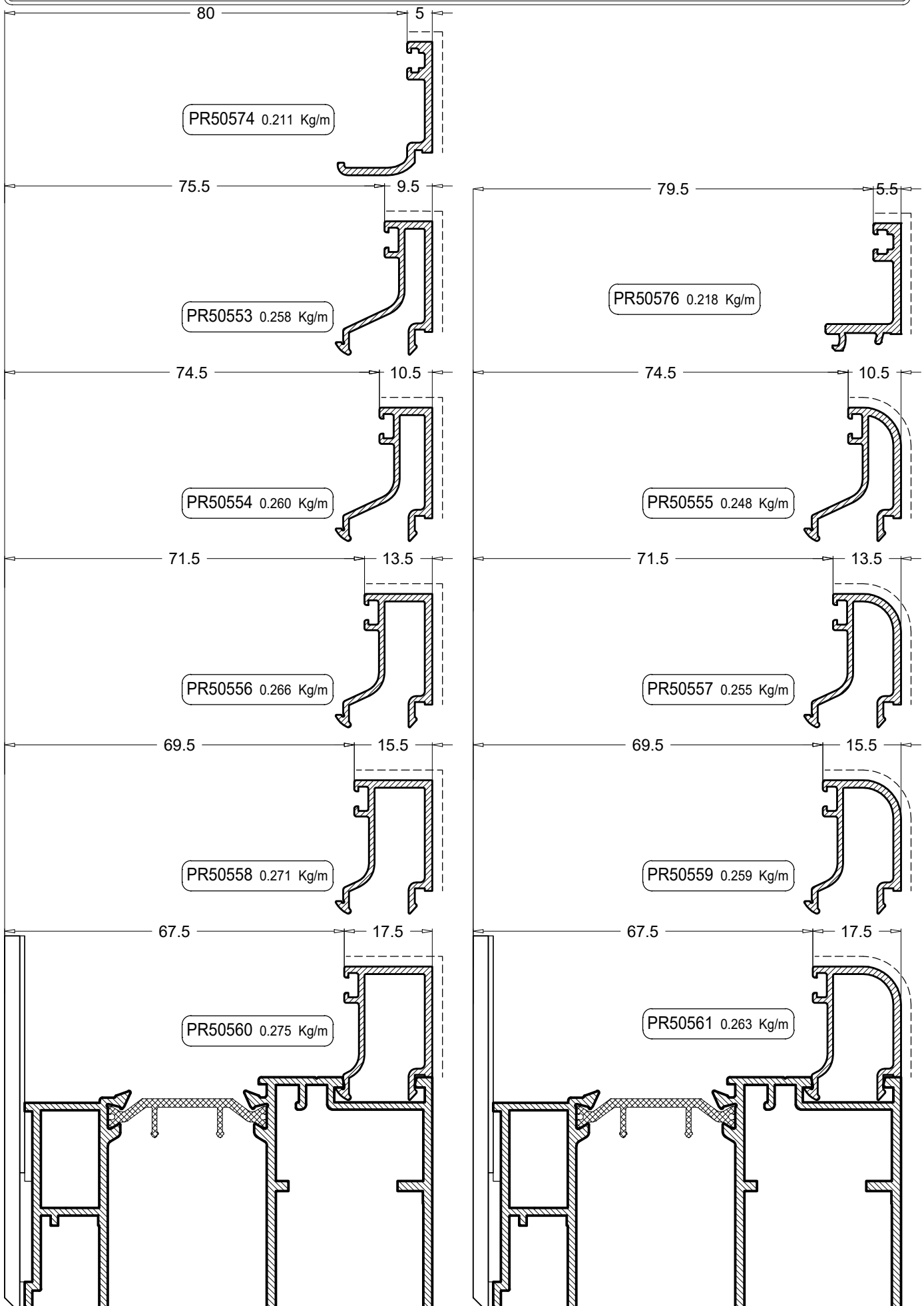

Jednokrilna panel vrata - Široki štok

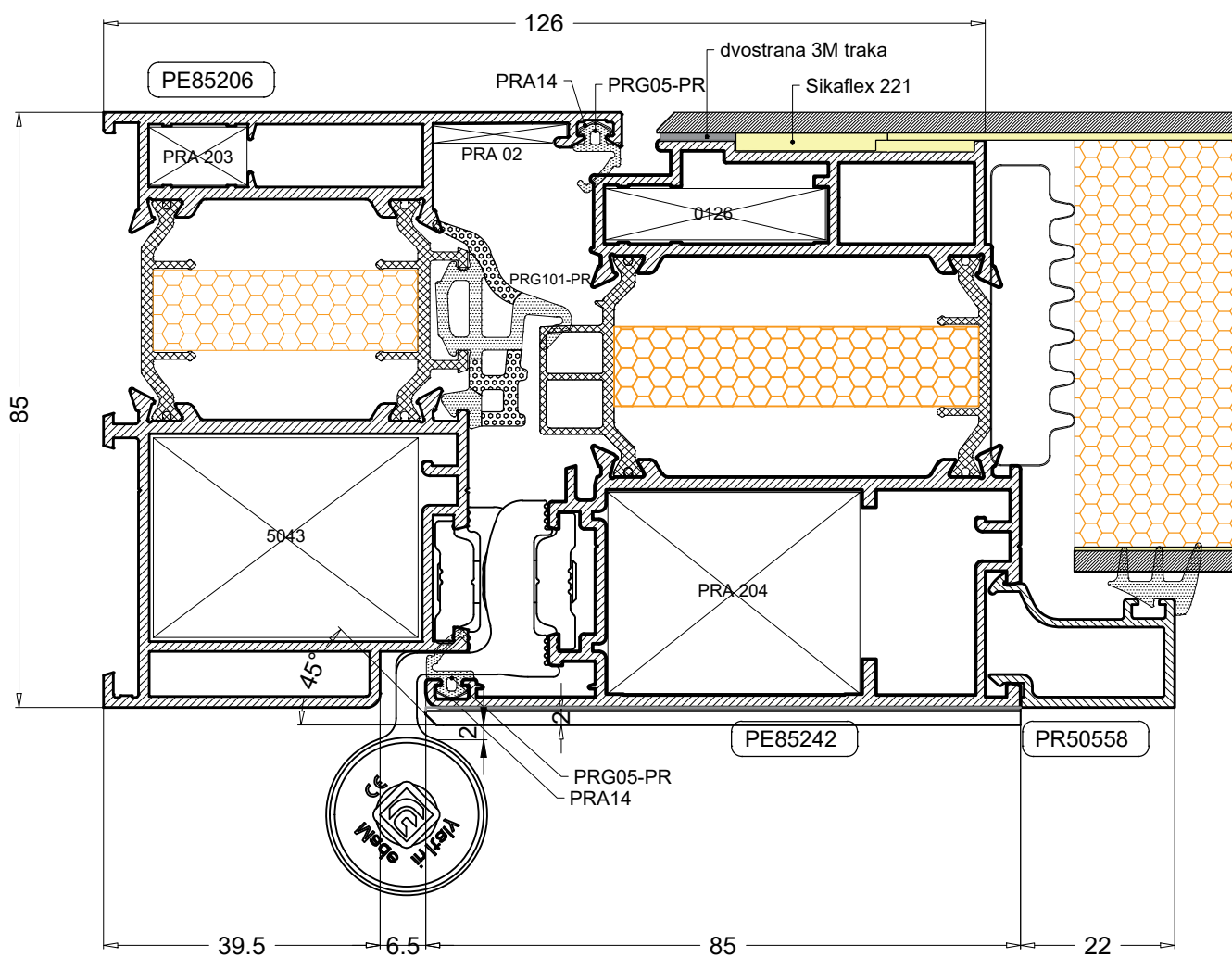
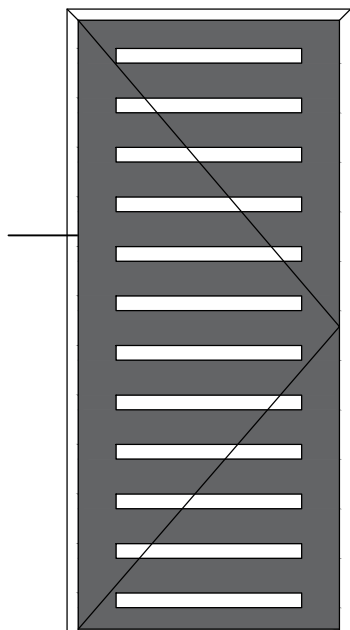

Jednokrilna panel vrata - Široki štok

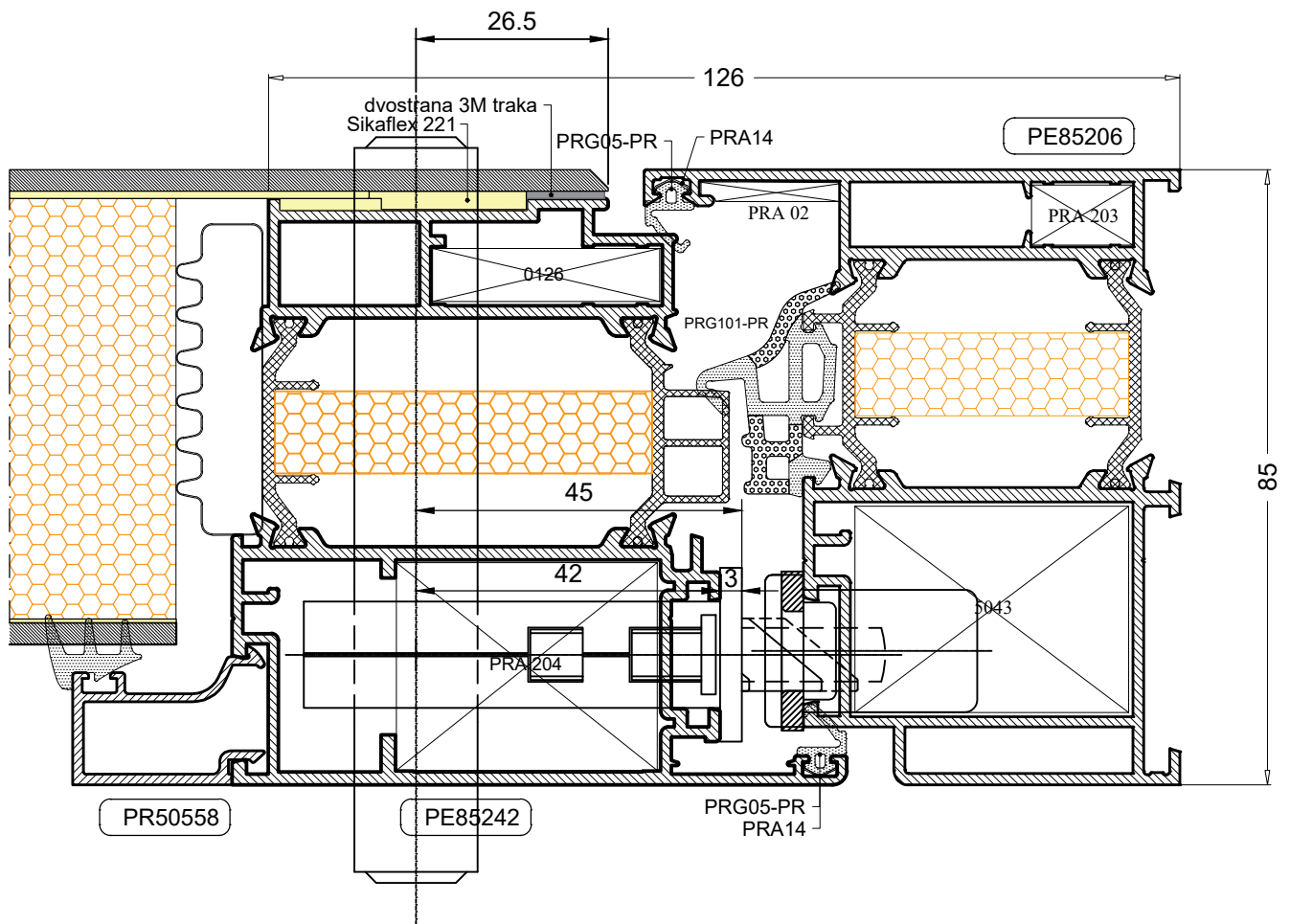
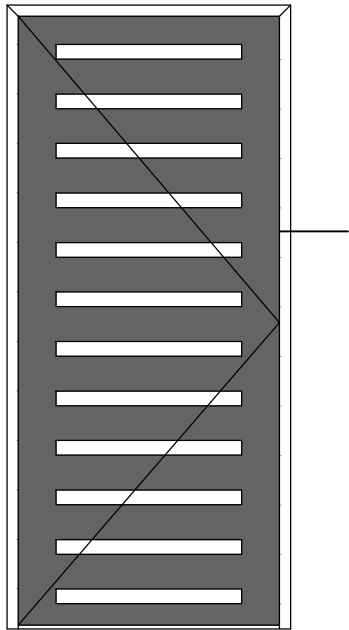

Jednokrilna panel vrata - Široki štok

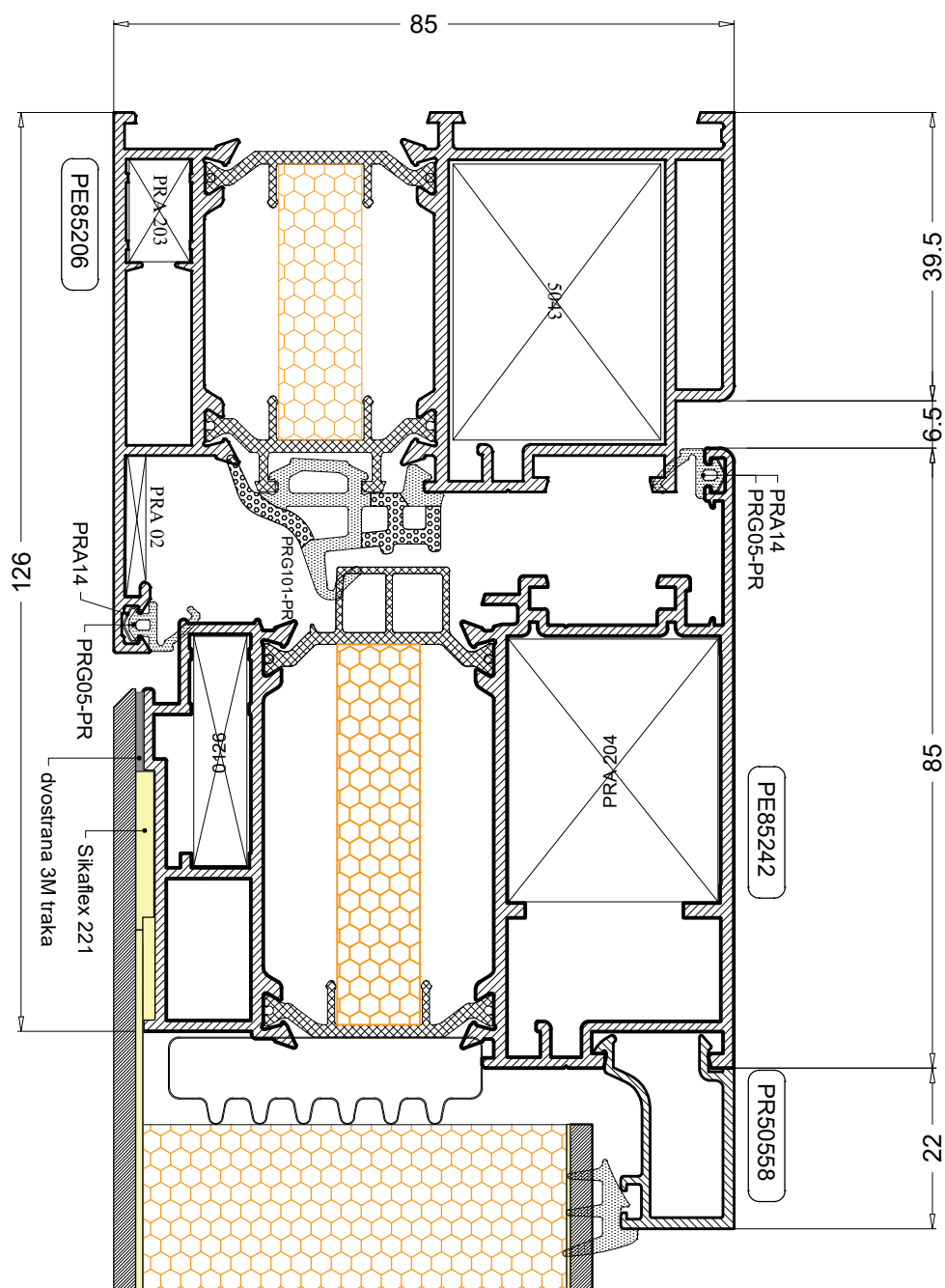
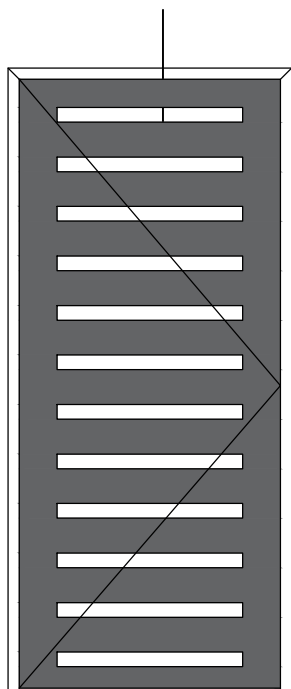



Jednokrilna panel vrata - Široki štok

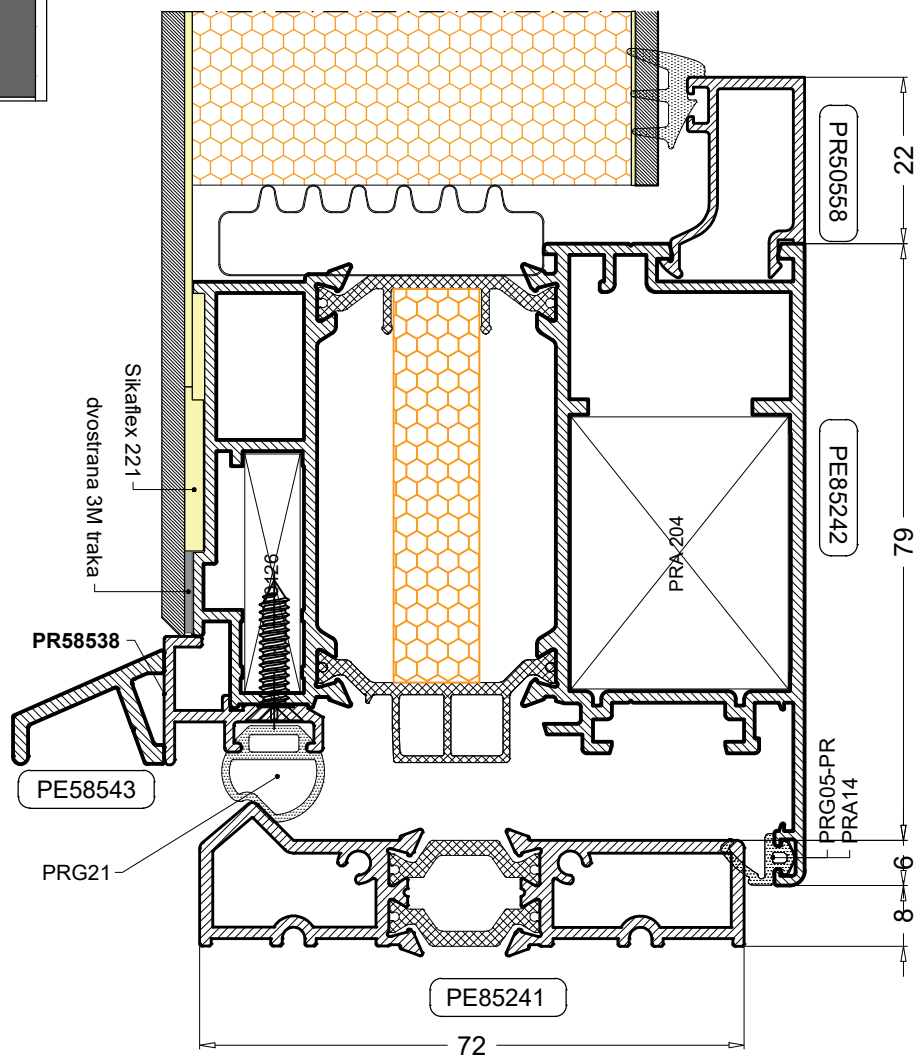
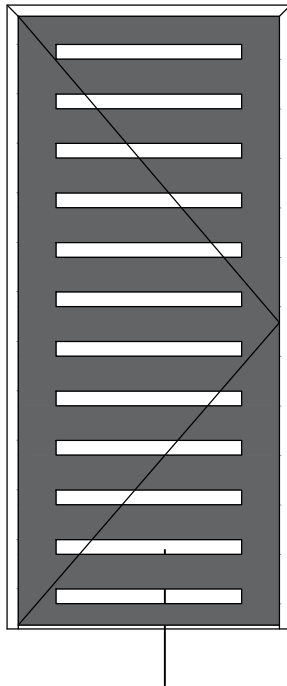

Jednokrilna panel vrata sa fiksnim dijelom - Široki štok

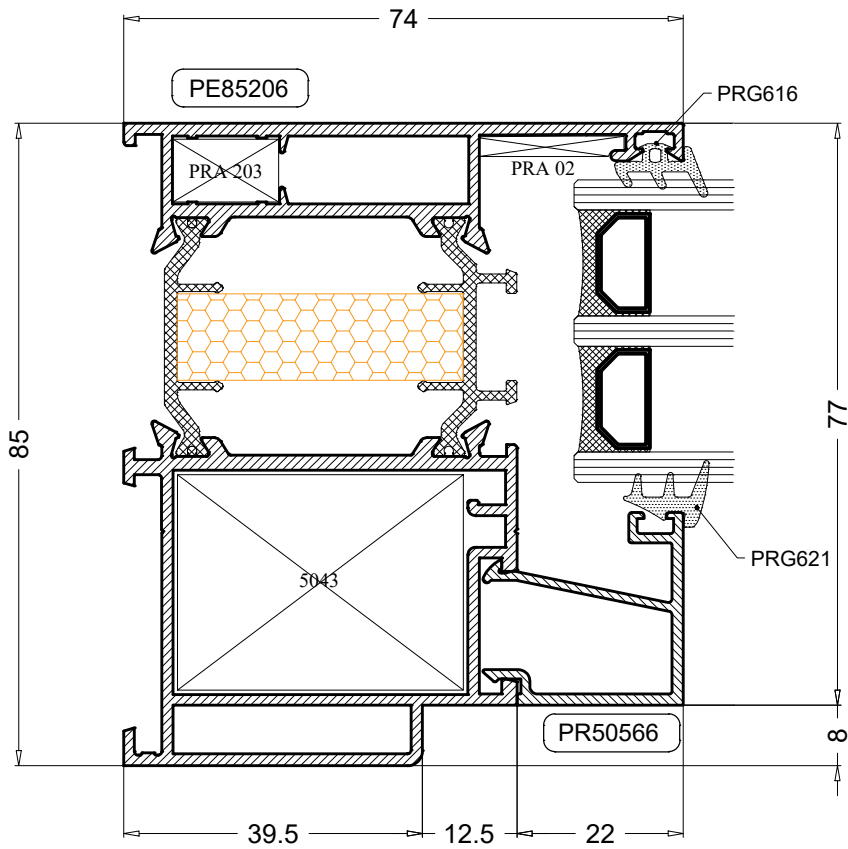
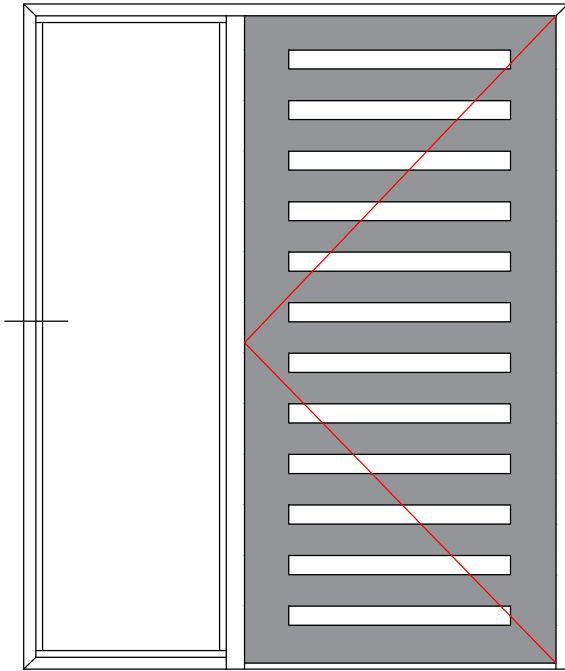

Jednokrilna panel vrata sa fiksnim dijelom - Široki štok

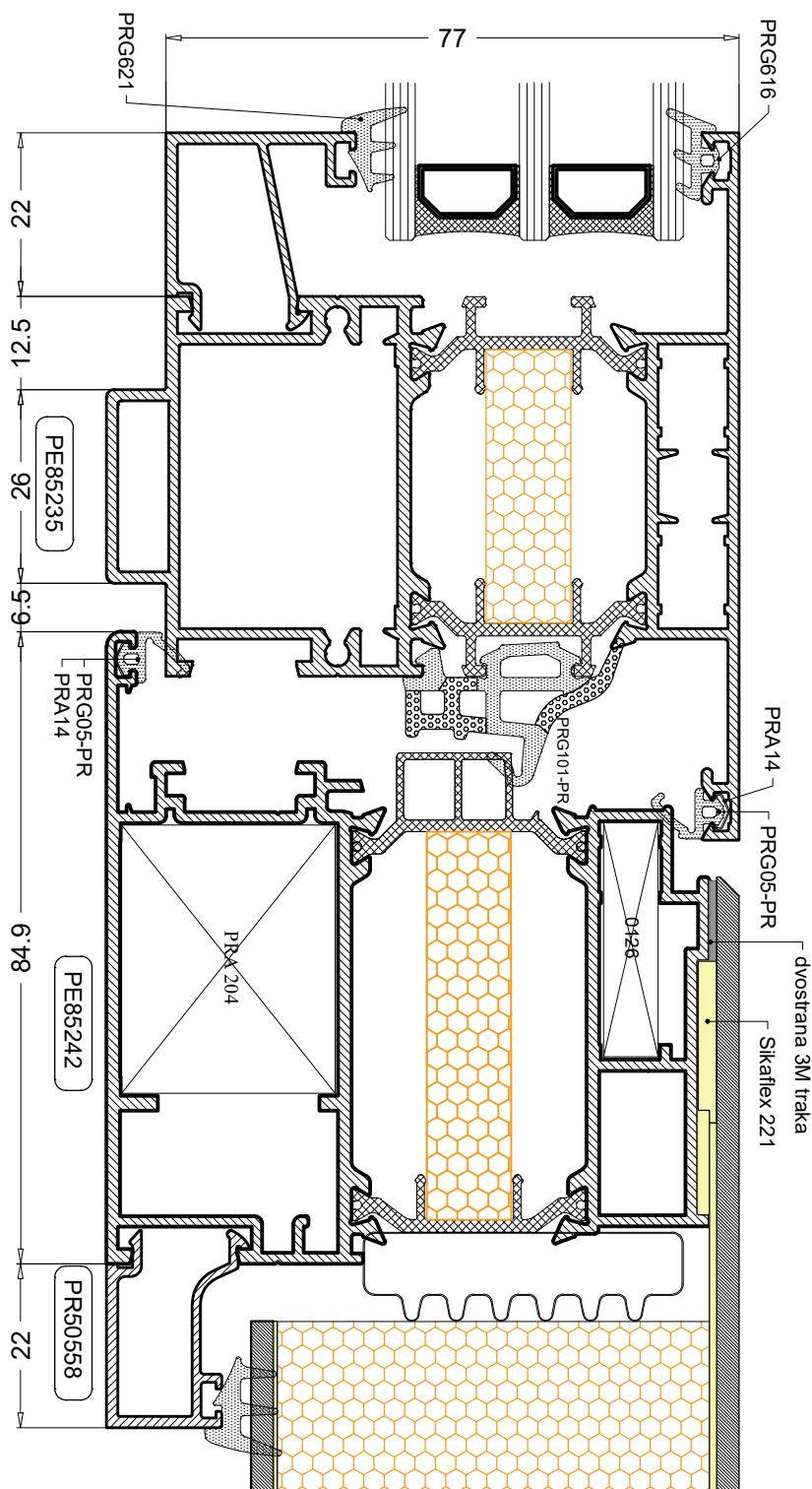
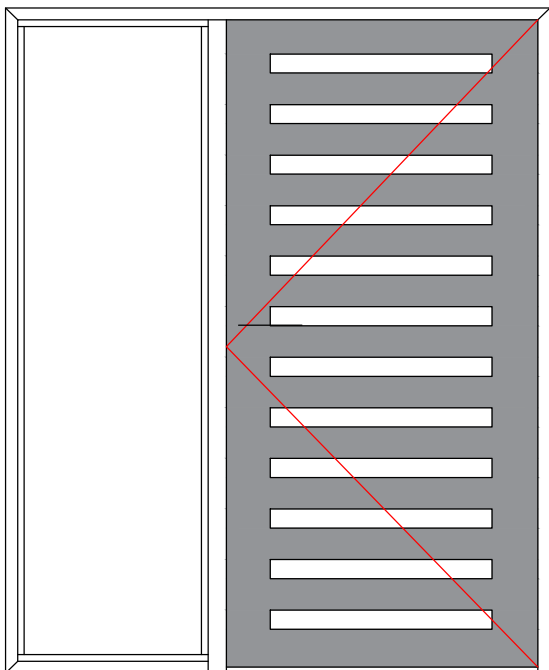

Jednokrilna vrata - Široki štok

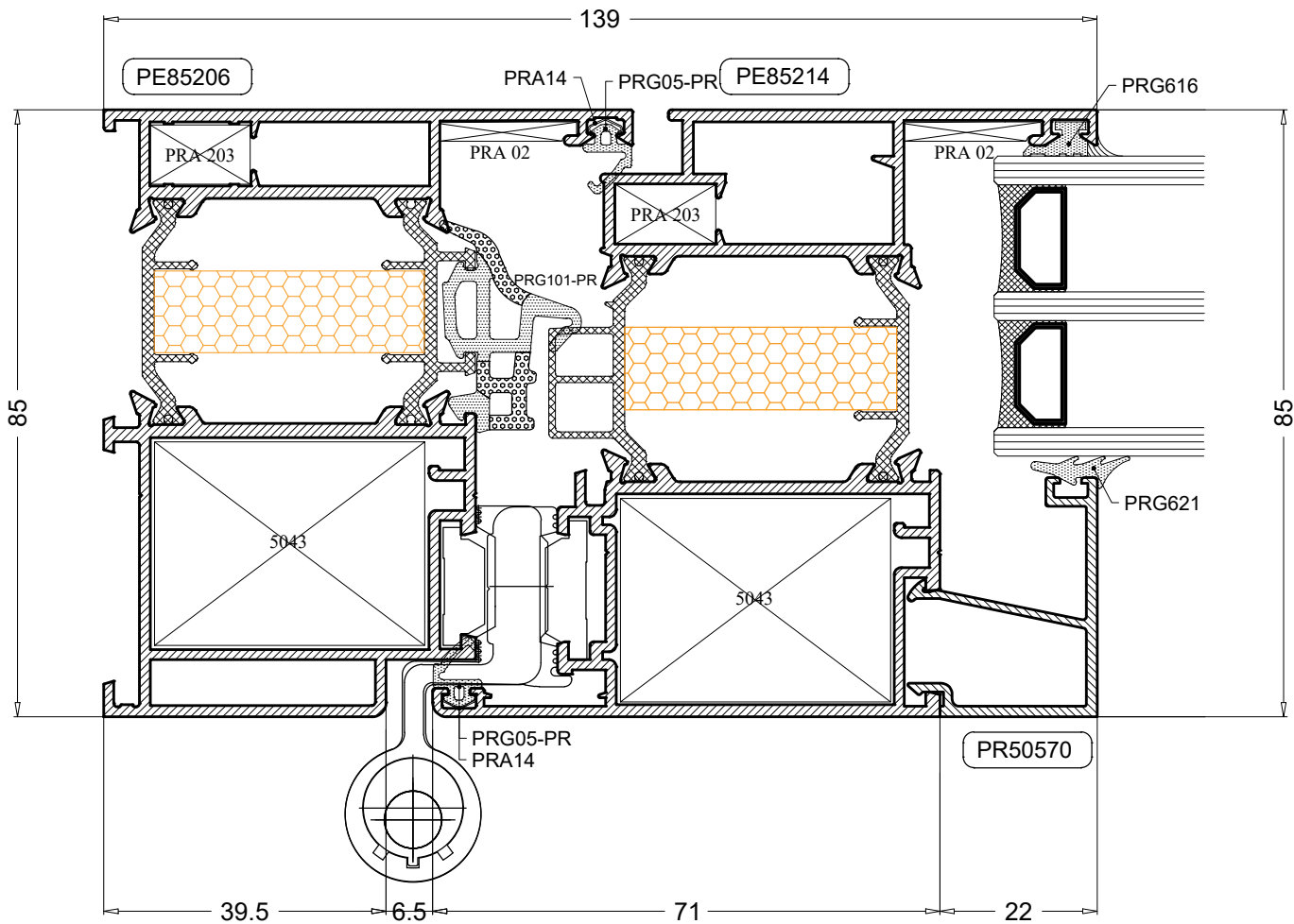
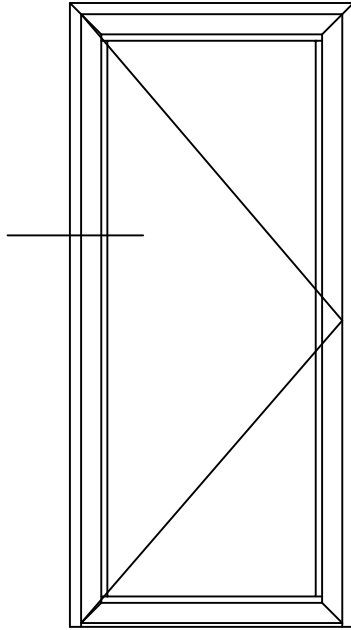

Jednokrilna vrata - Široki štok

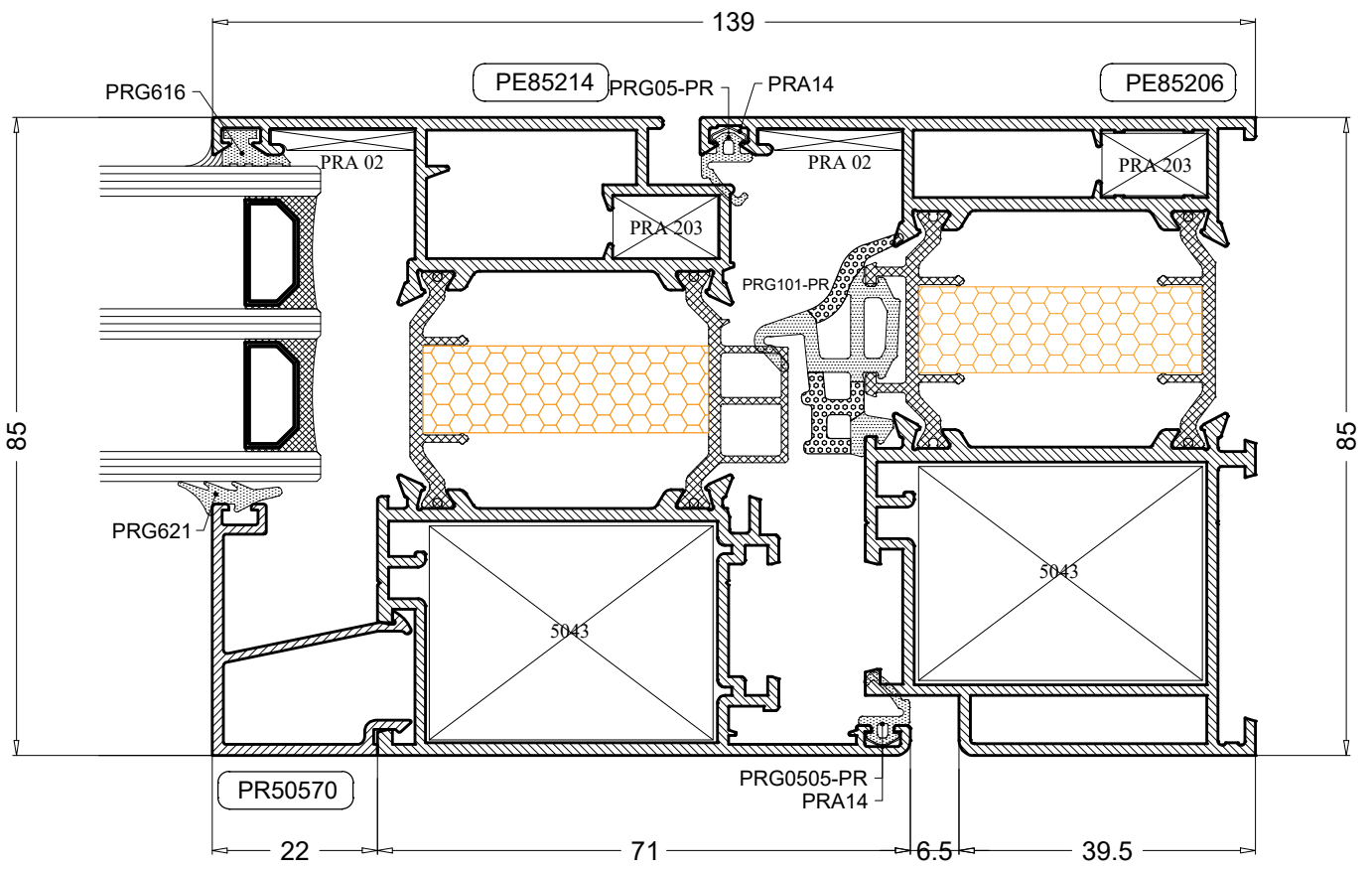
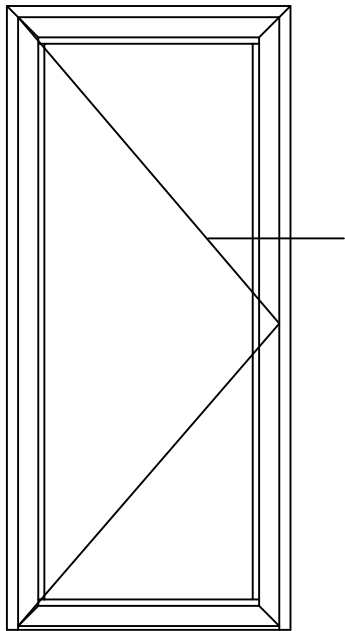

Jednokrilna vrata - Široki štok

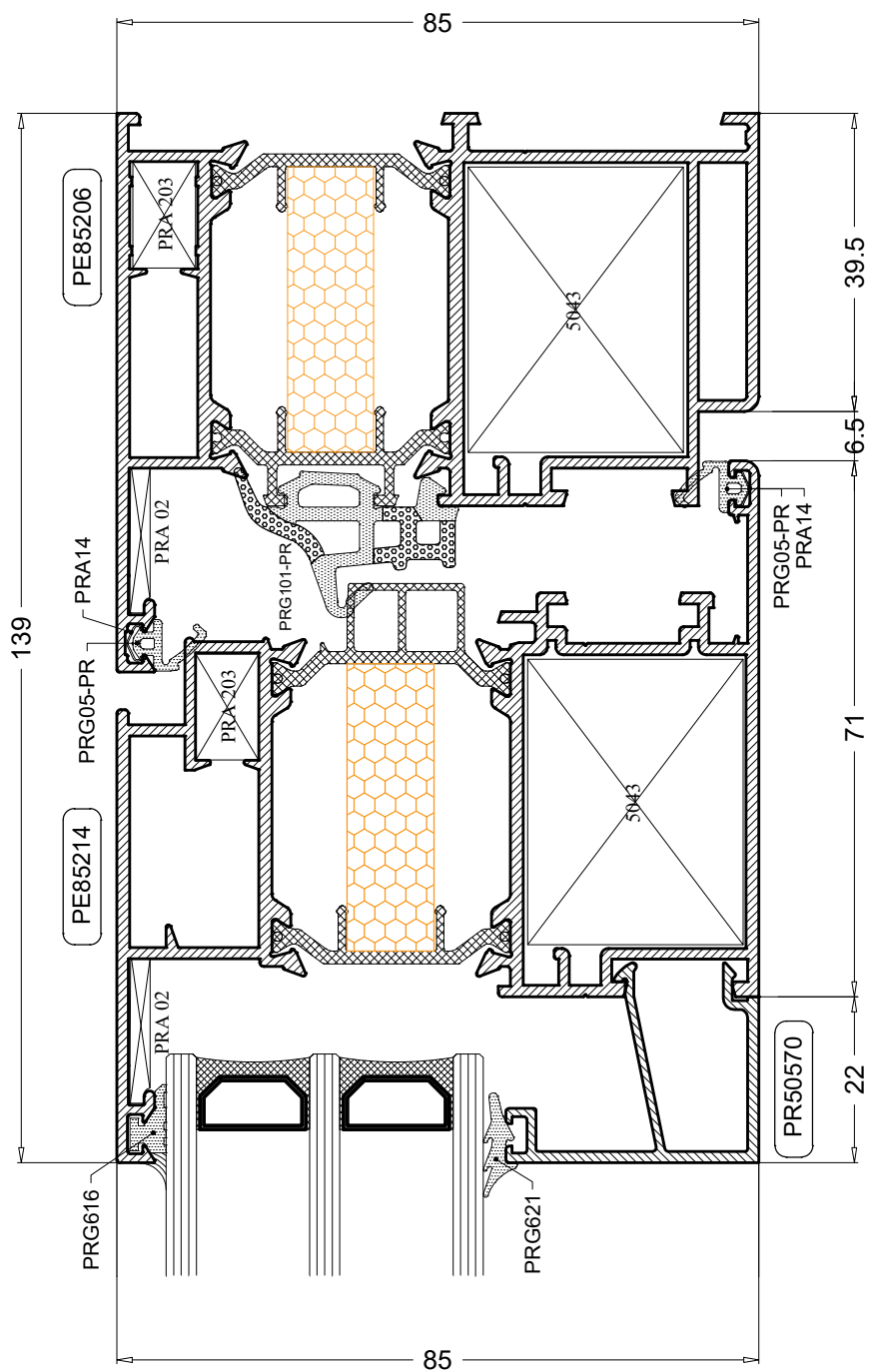
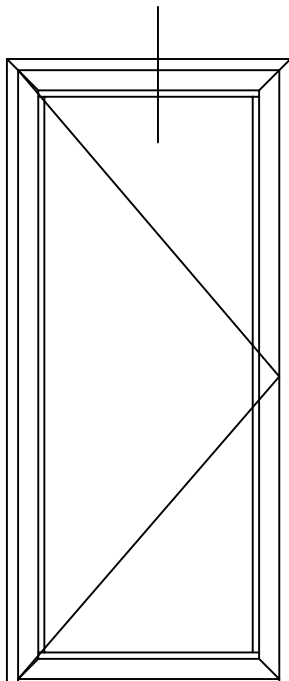

Jednokrilna vrata sa fiksnim dijelom - Široki štok

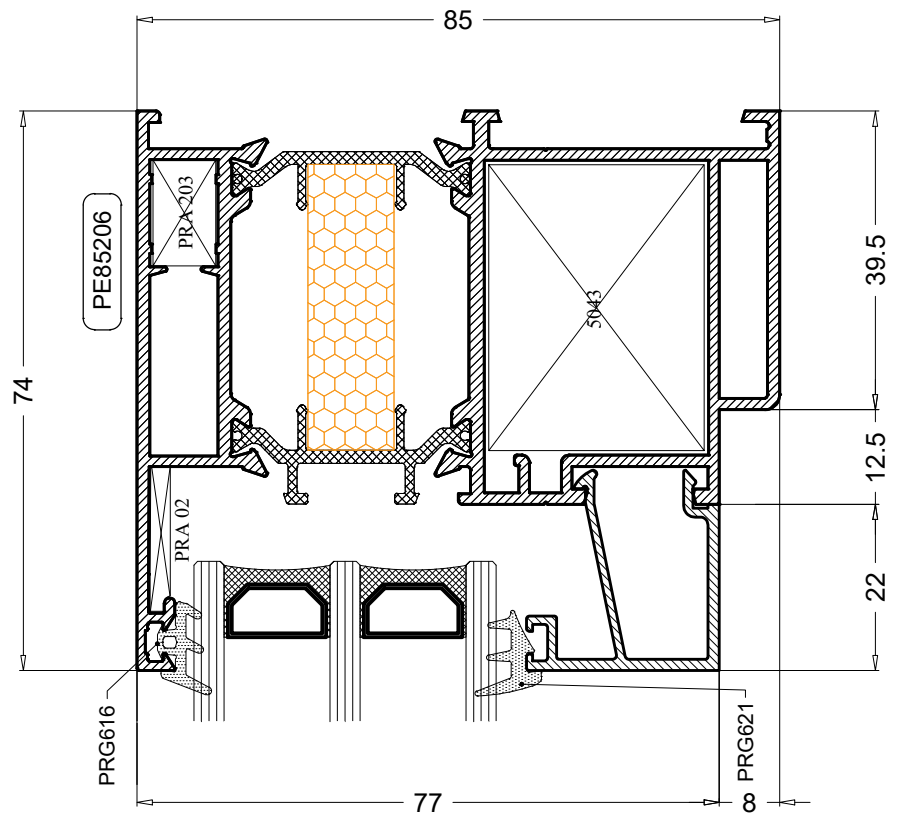
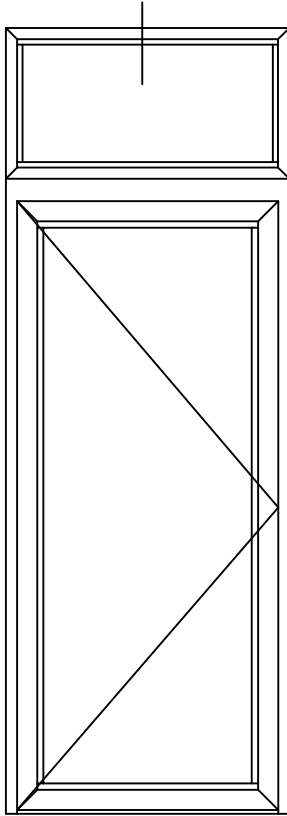

Jednokrilna vrata - Presjek sa pragom

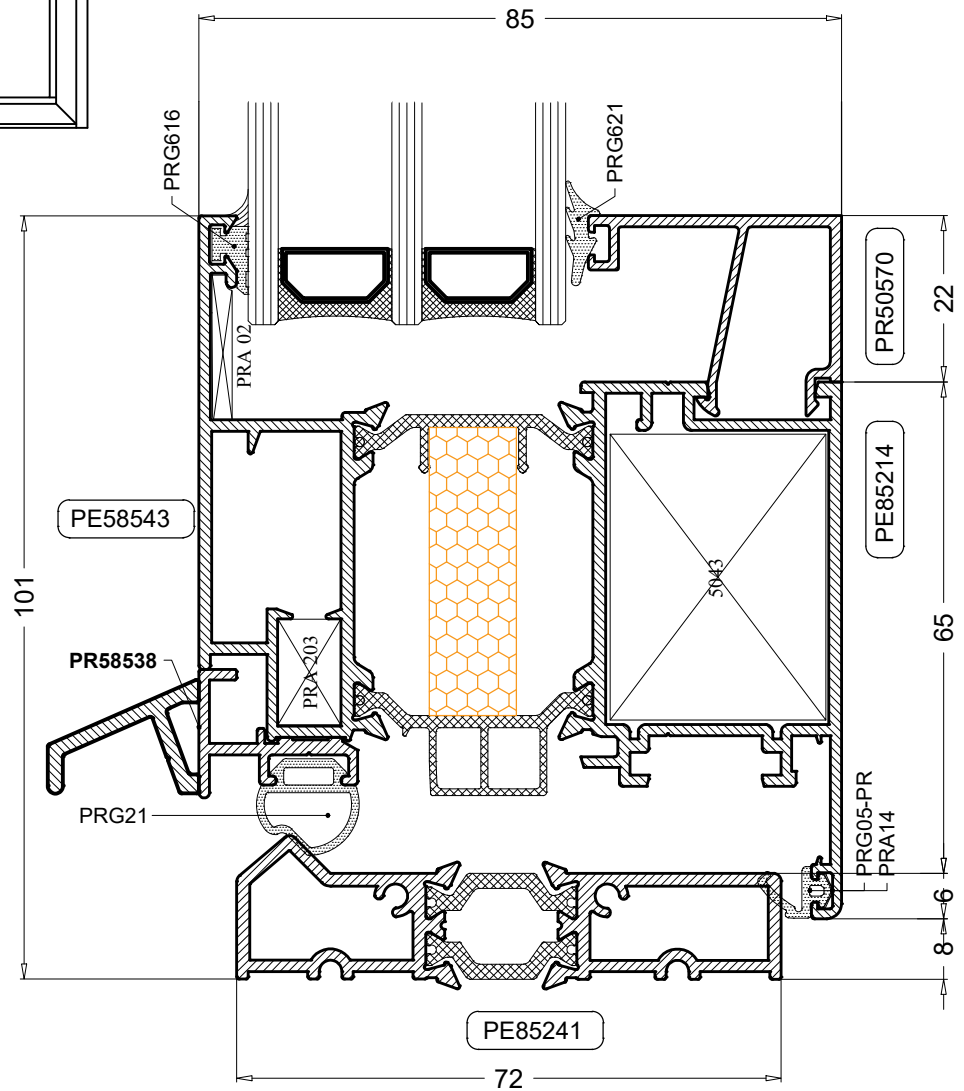
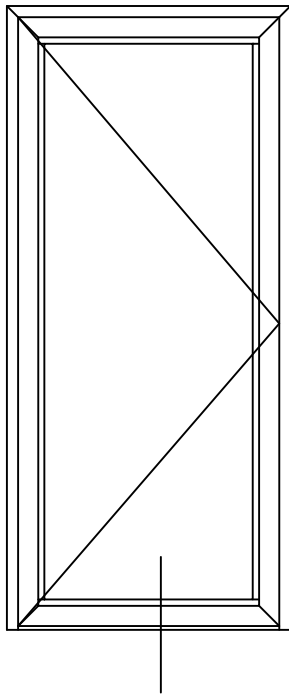



Jednokrilna vrata sa fiksnim dijelom - Široki štok

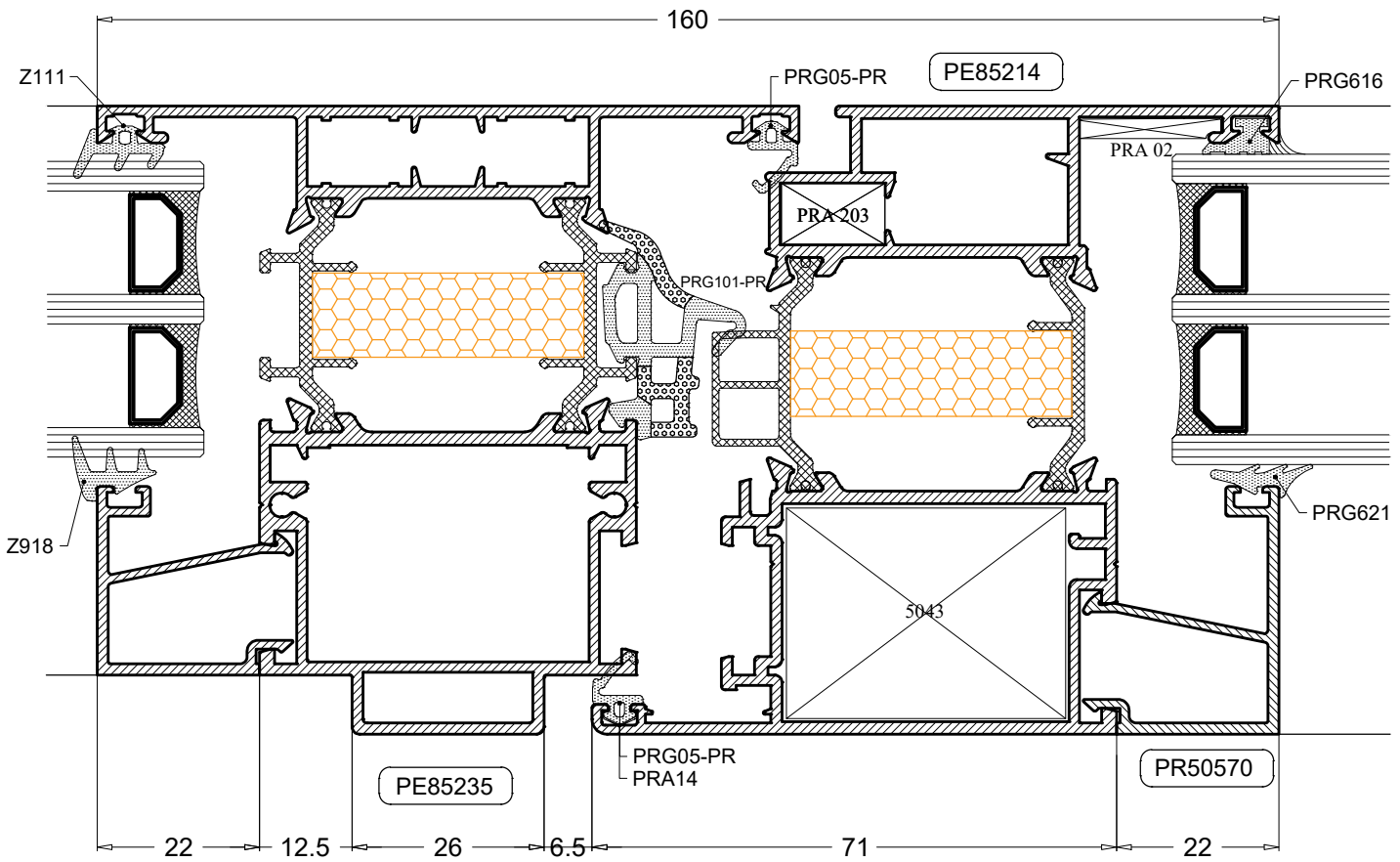
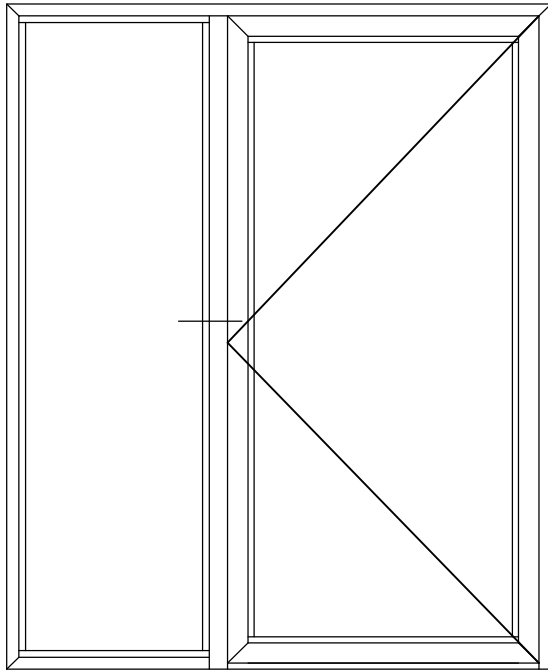

Jednokrilna vrata sa ventusom - Široki štok

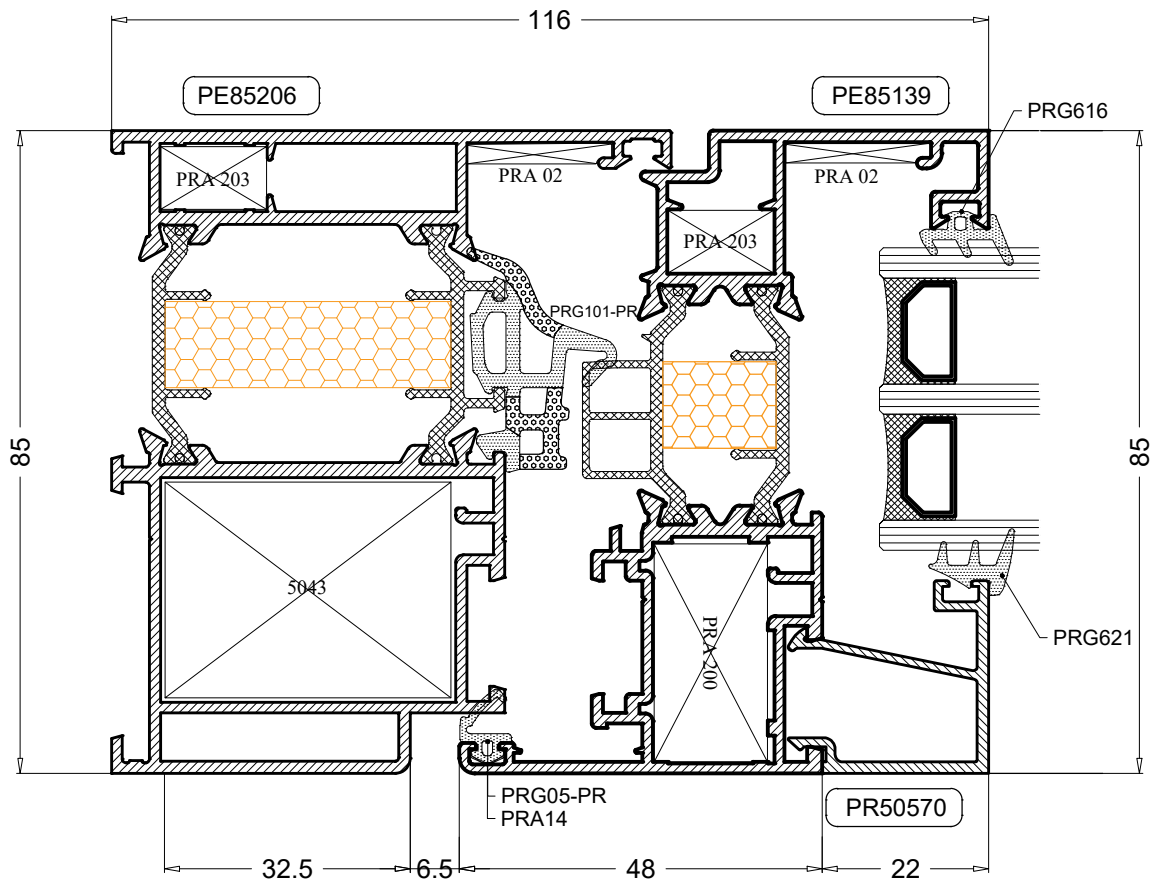
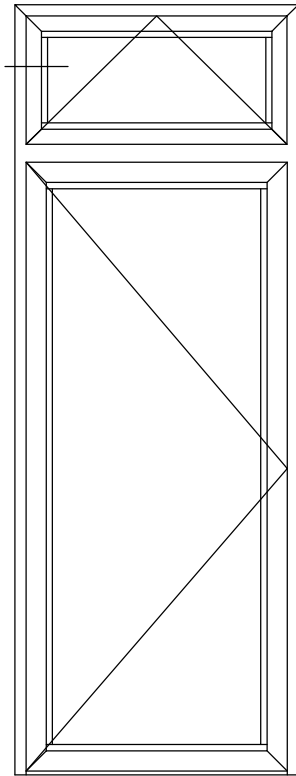

Jednokrilna vrata sa ventusom - Široki štok

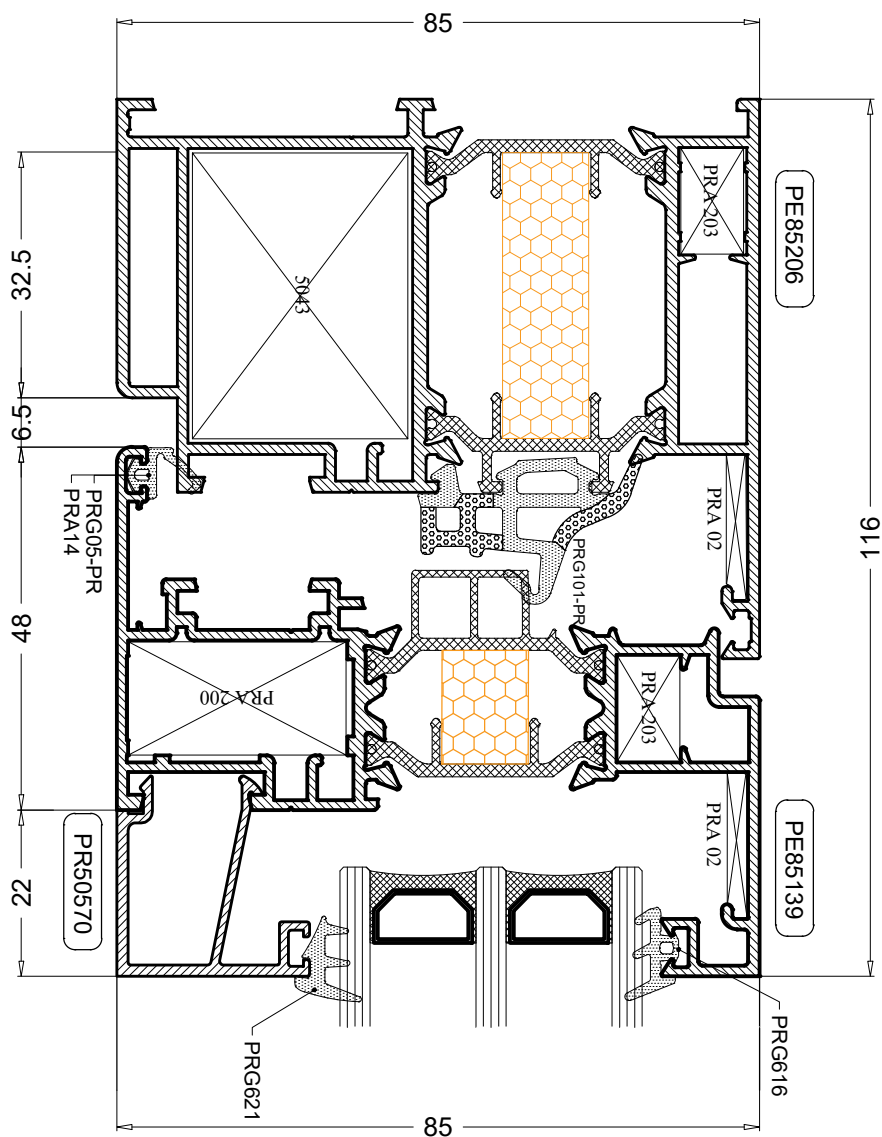
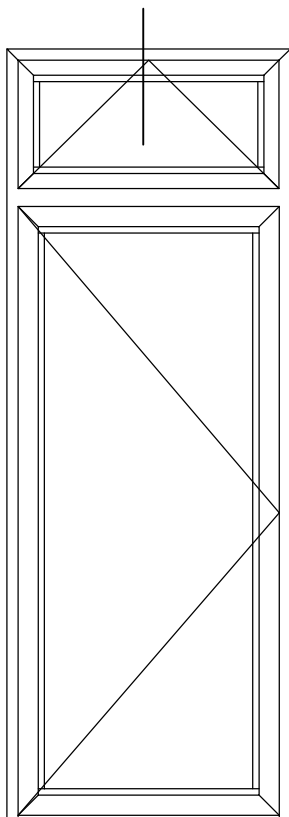

Jednokrilna vrata - Uski štok

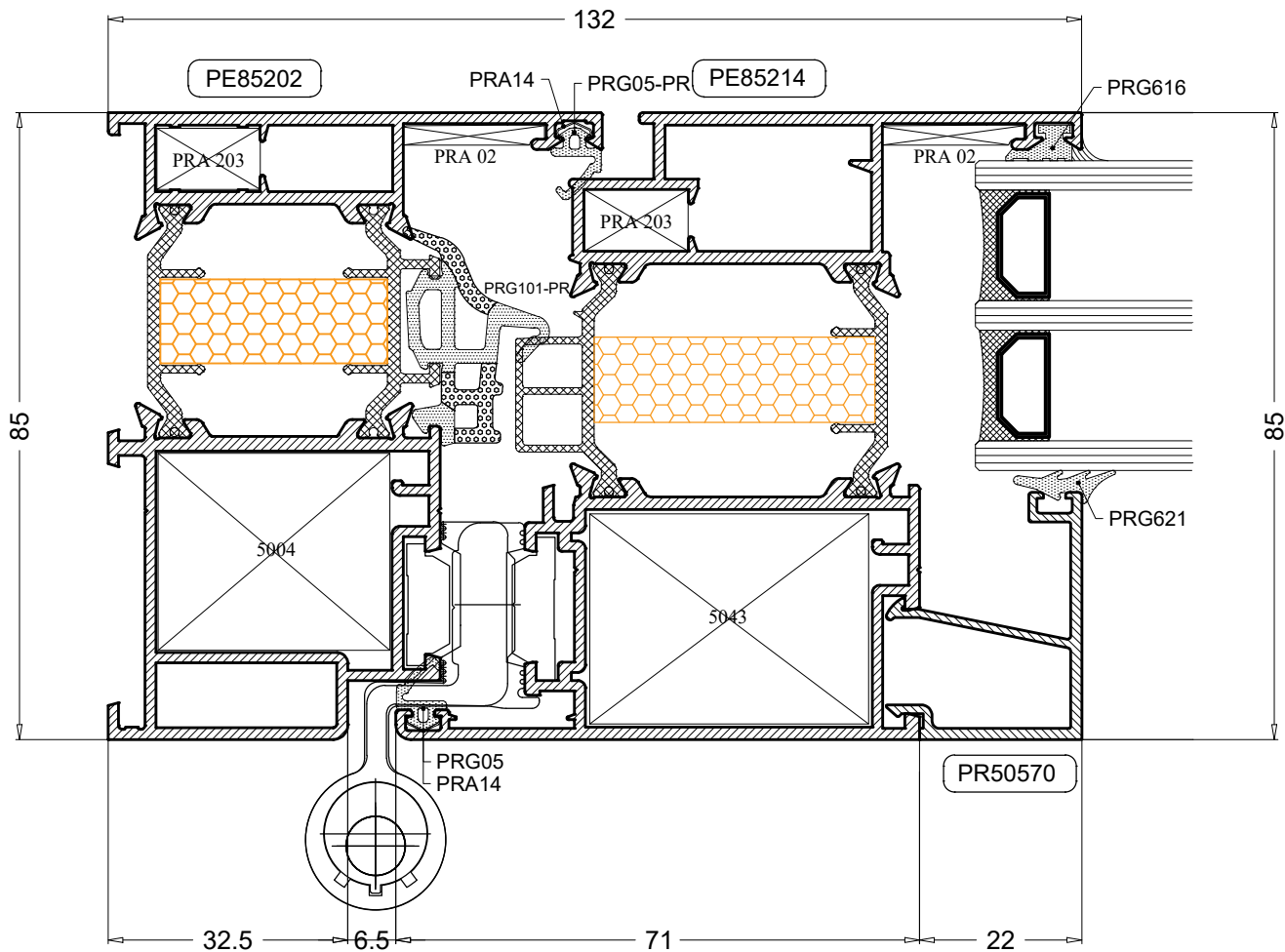
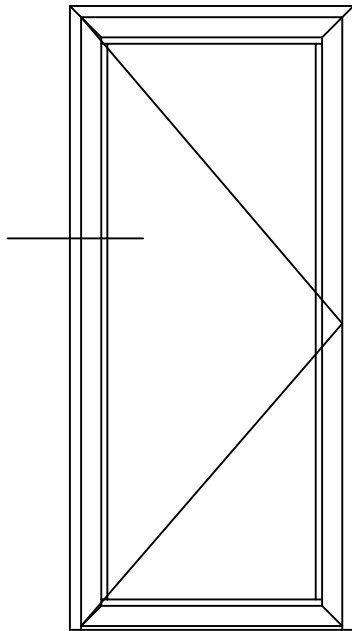

Jednokrilna vrata - Uski štok

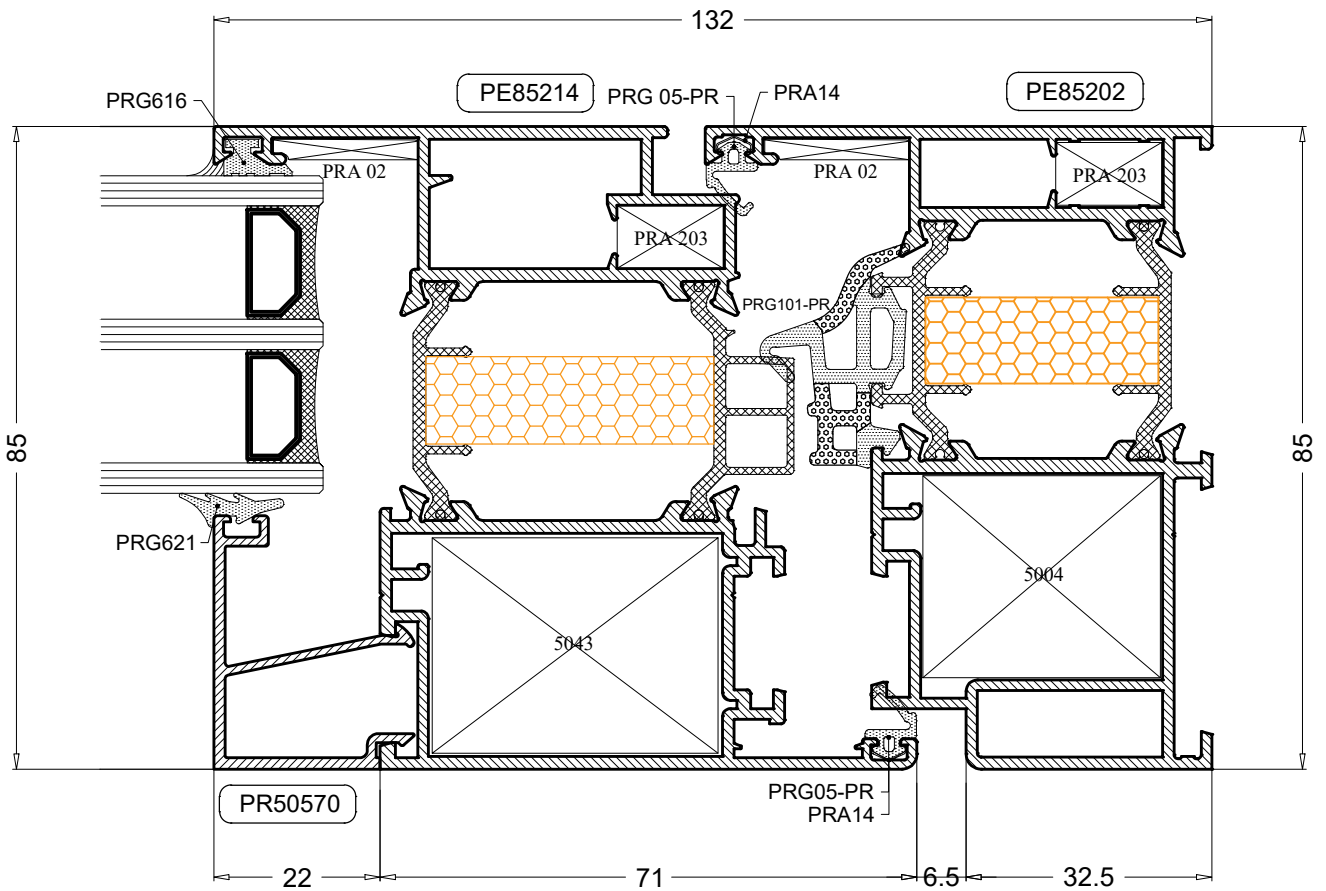
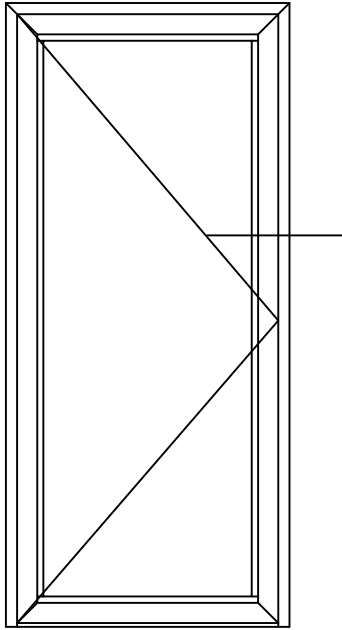

Jednokrilna vrata - Uski štok

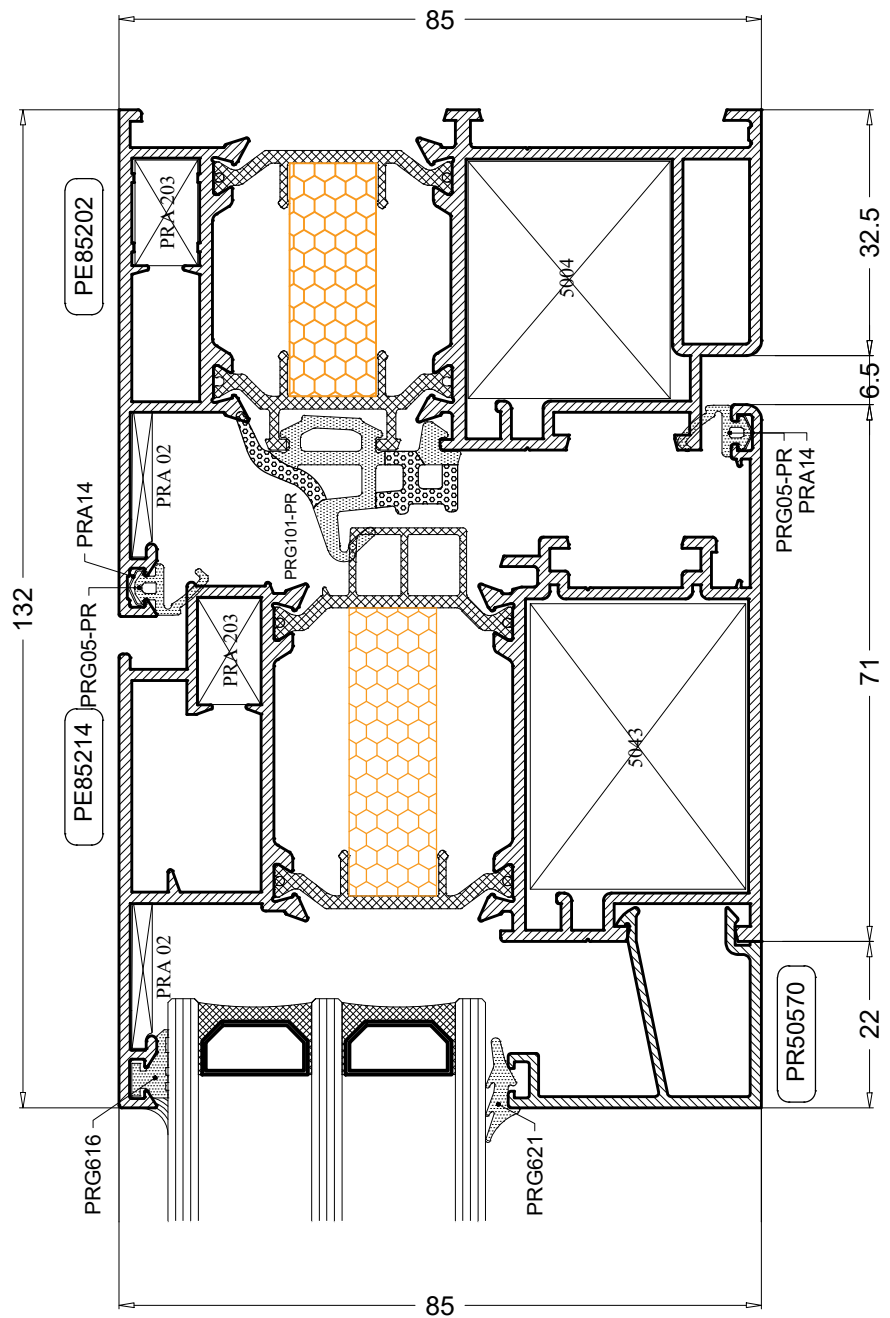
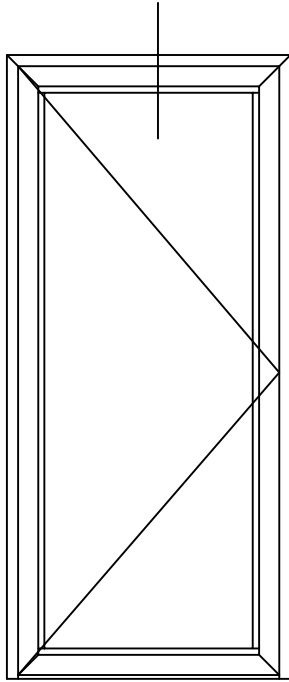

Jednokrilna vrata sa gornjim fiksnim dijelom

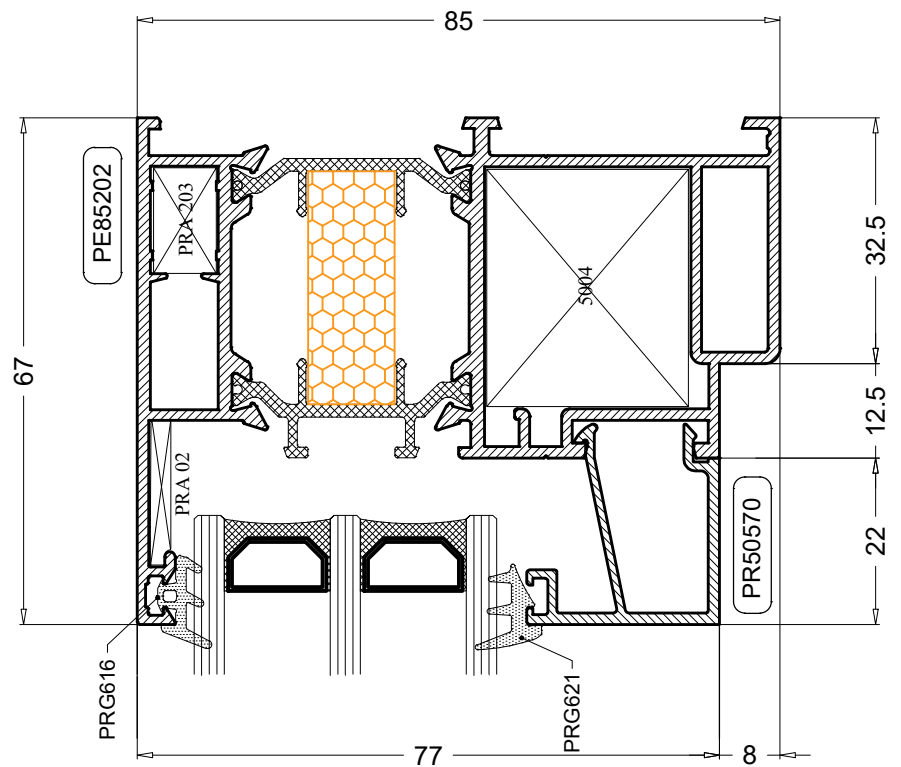
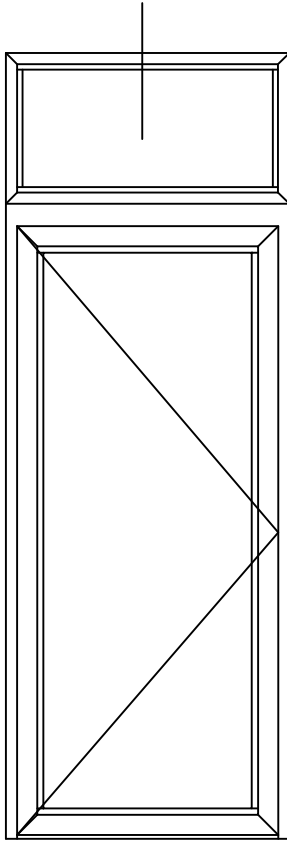

Jednokrilna vrata sa fiksnim dijelom - Uski štok

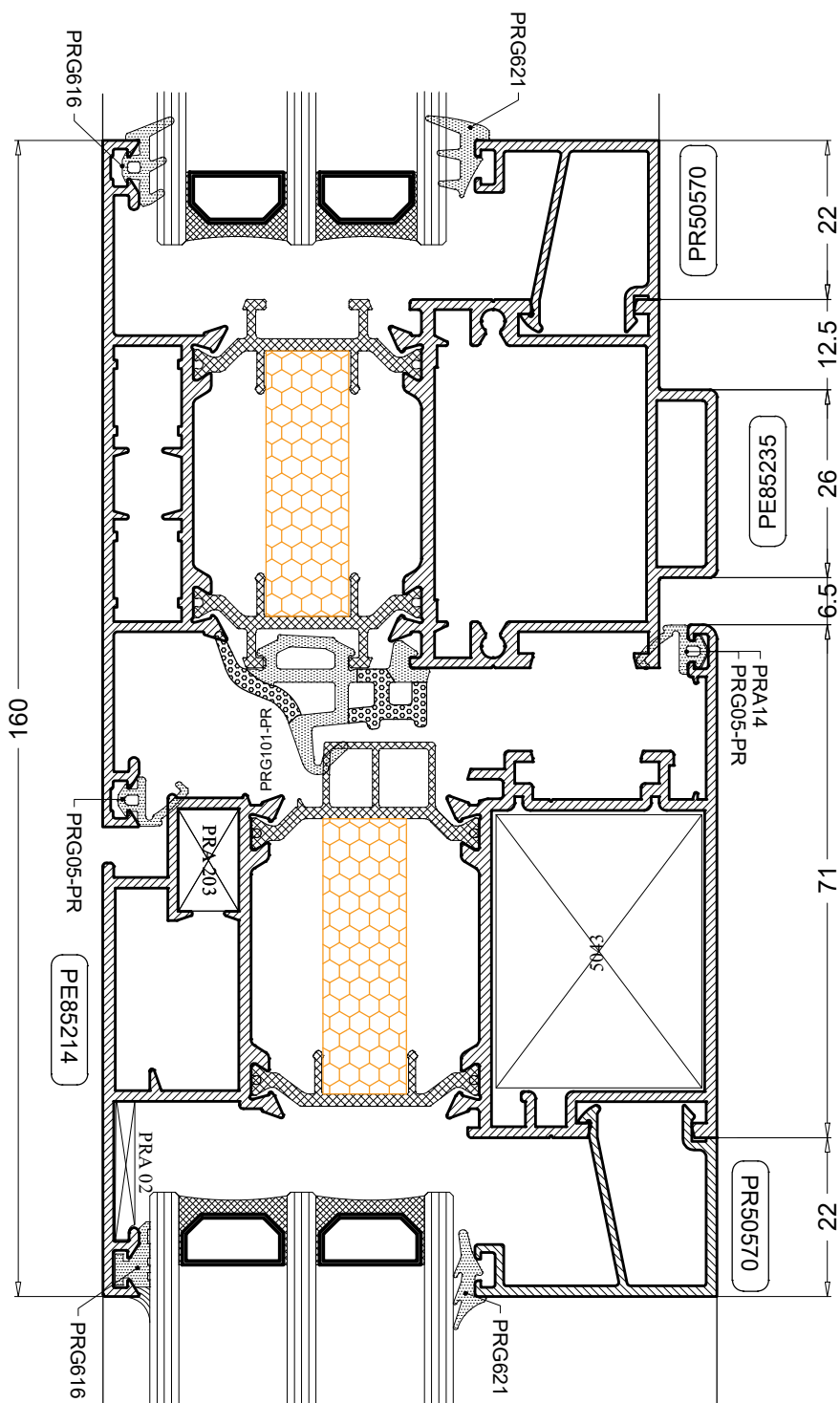
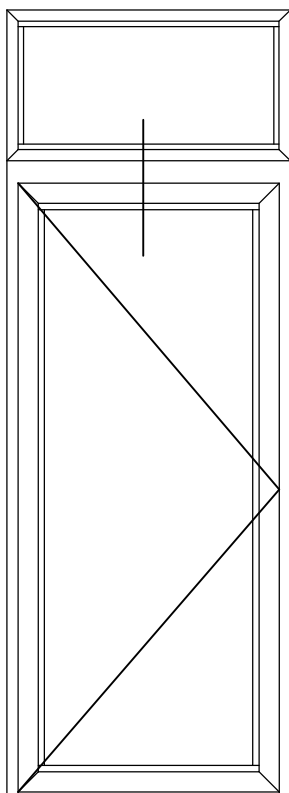



Jednokrilna vrata sa fiksnim dijelom - Unutarne otvaranje - Uski štok

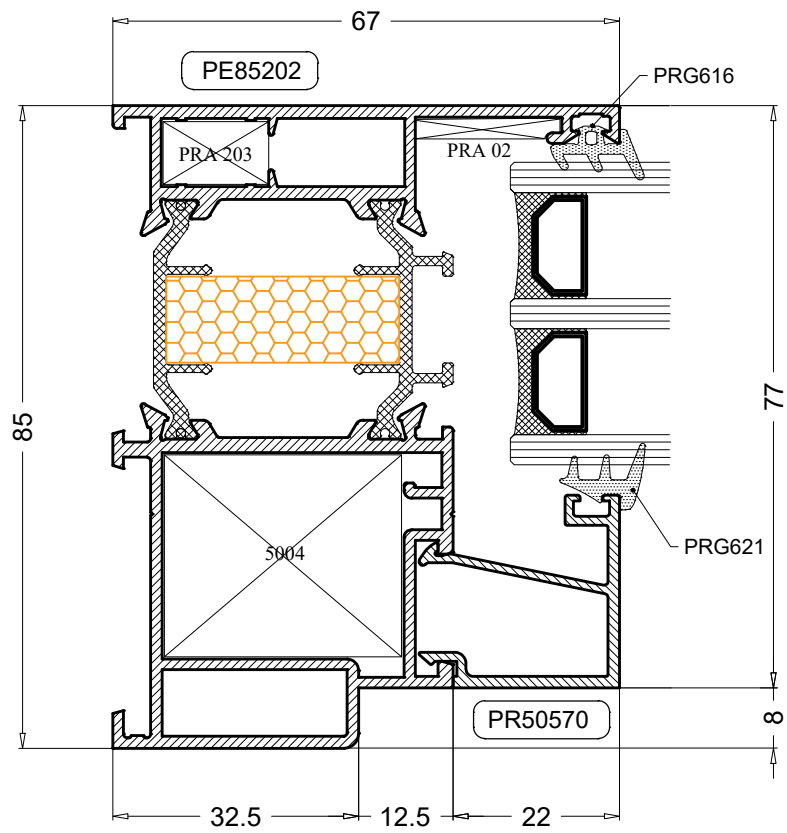
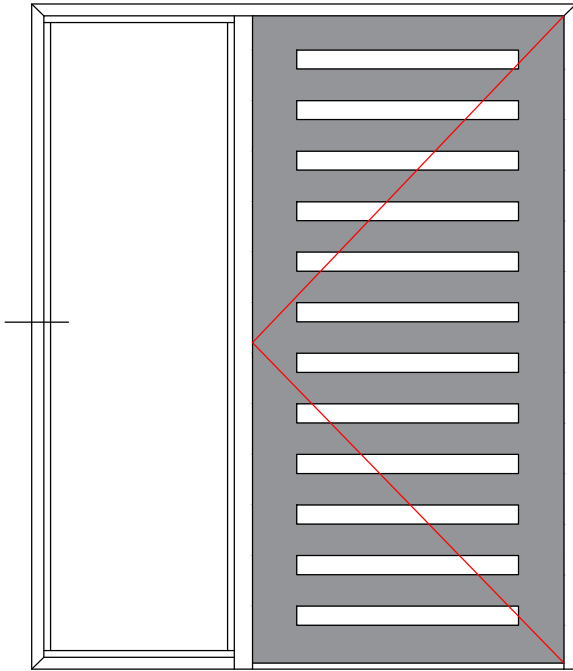

Jednokrilna vrata sa ventusom - Unutarnje otvaranje - Uski štok

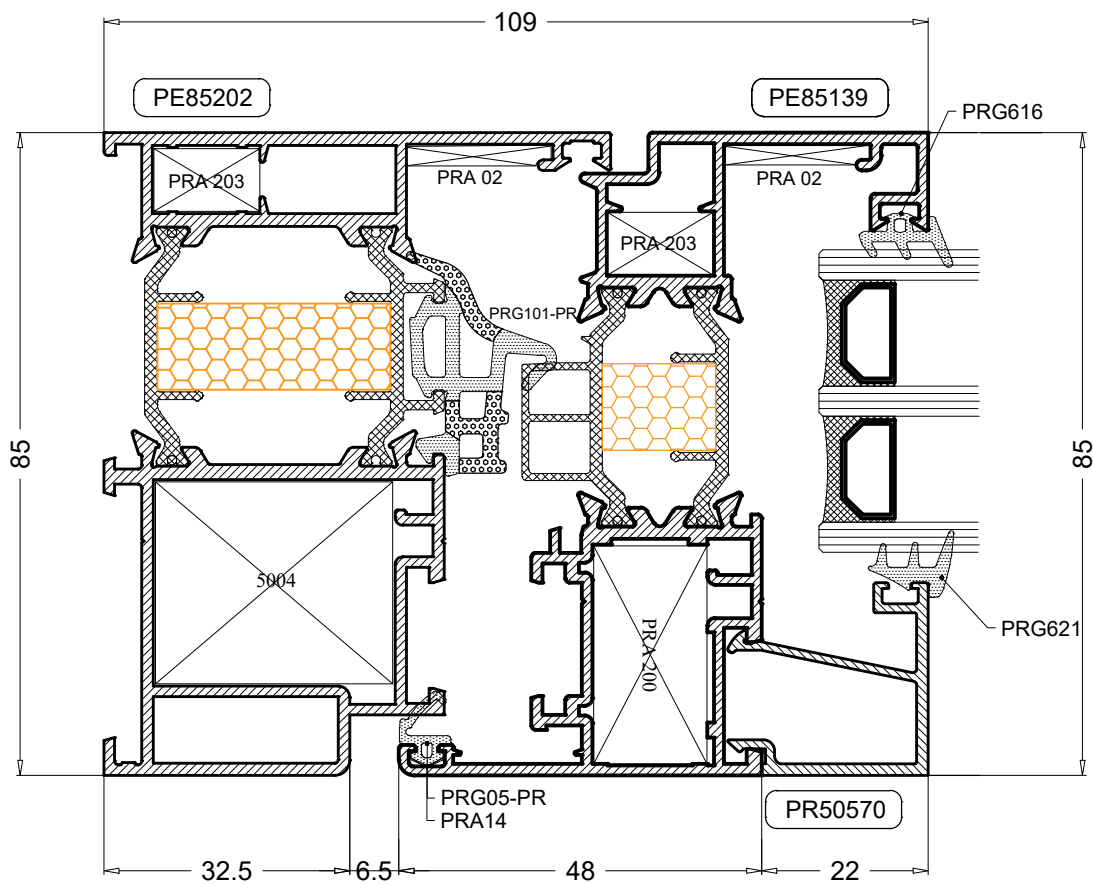
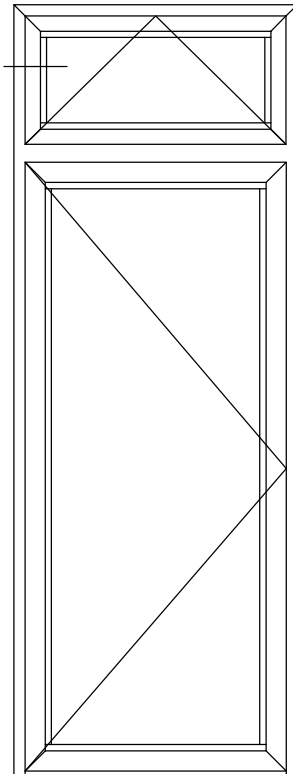

Jednokrilna vrata sa ventusom - Unutarnje otvaranje - Uski štok

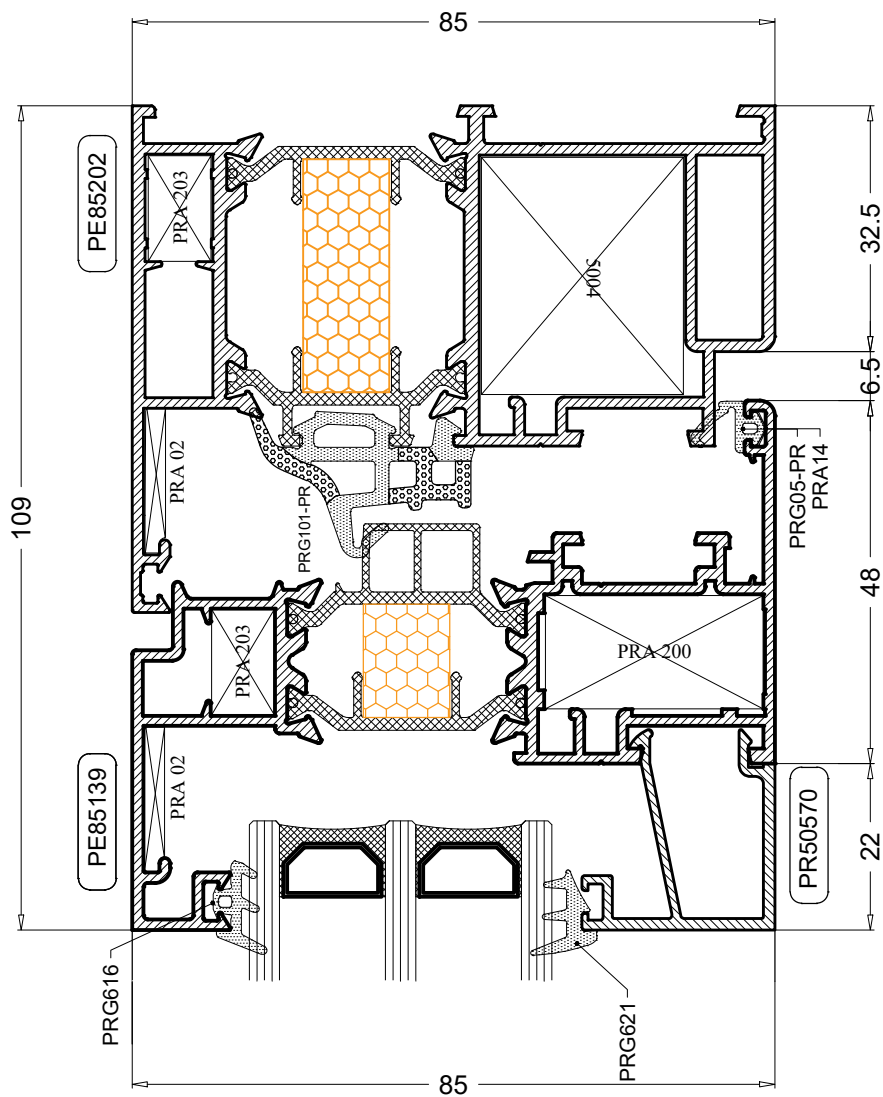
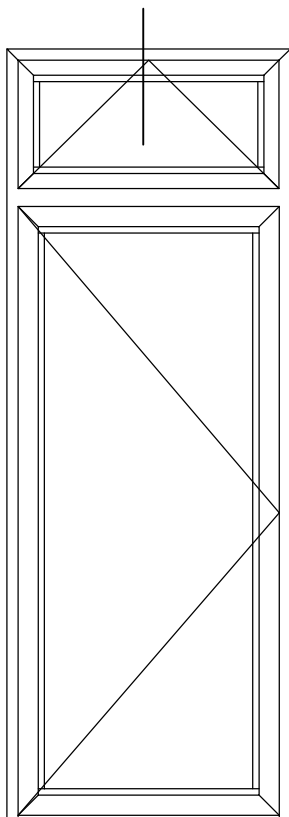

Jednokrilna vrata sa ventusom - Unutarnje otvaranje - Uski štok

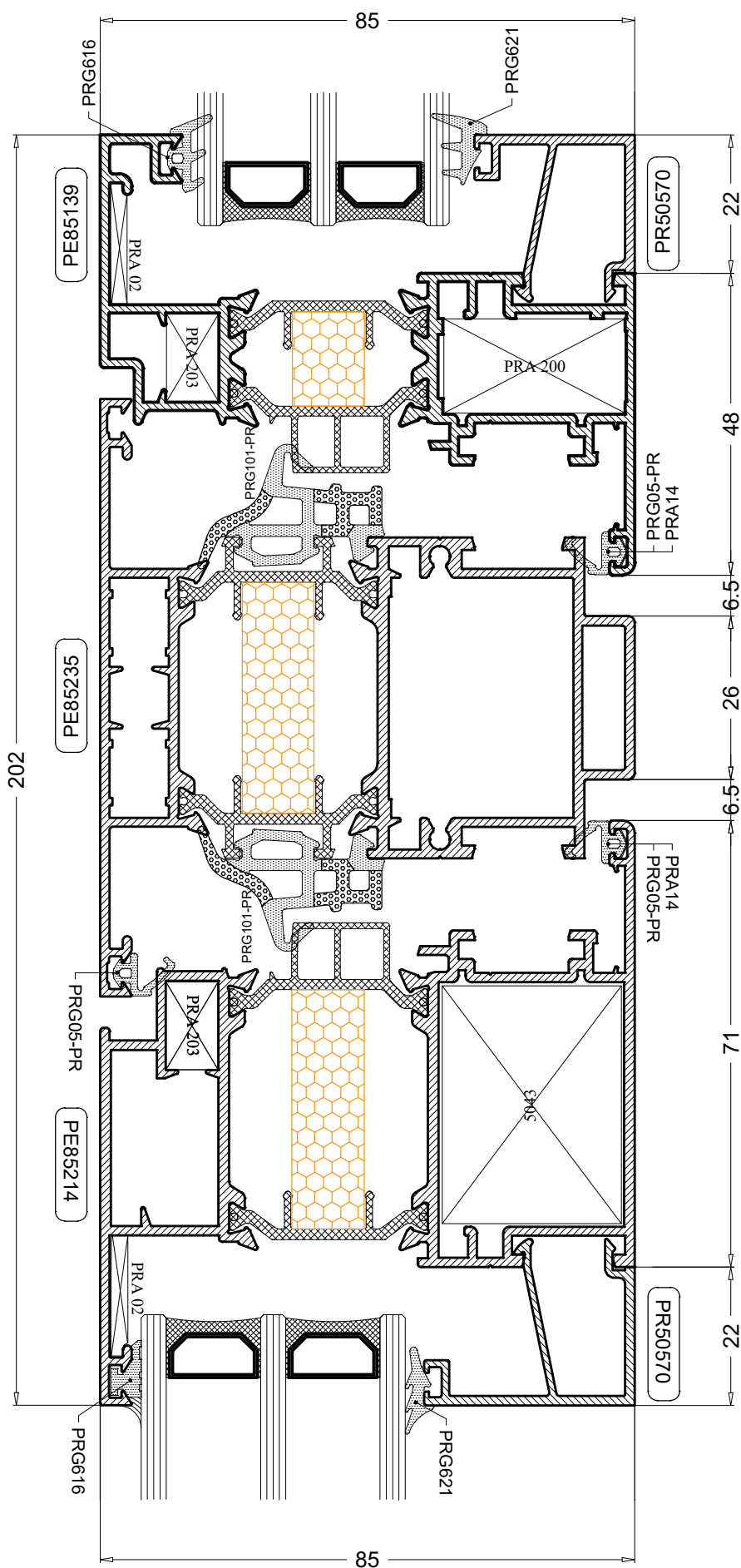
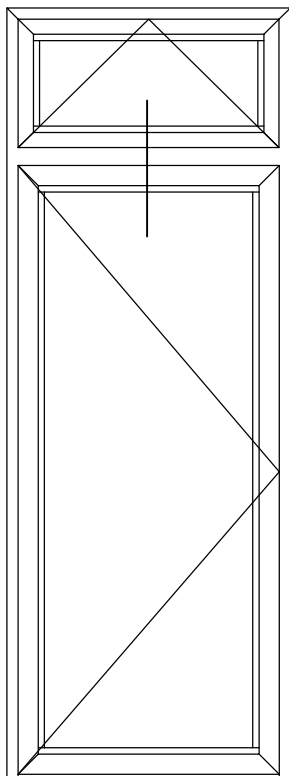

Rezne liste - Jednokrilna vrata/staklo - Veliki okvir

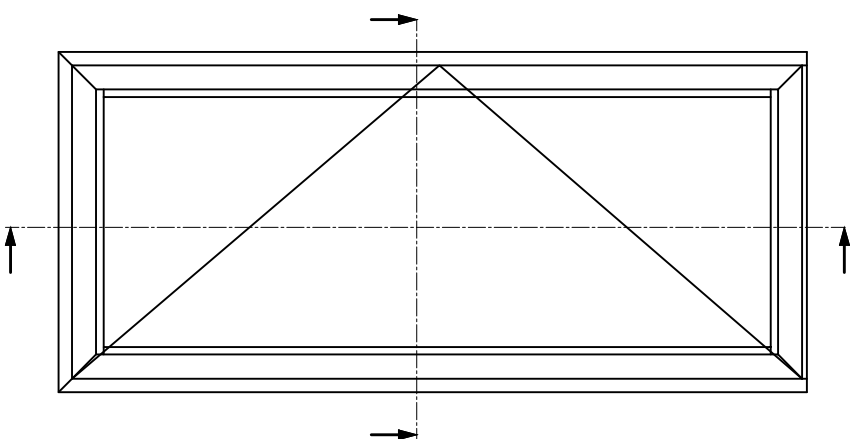
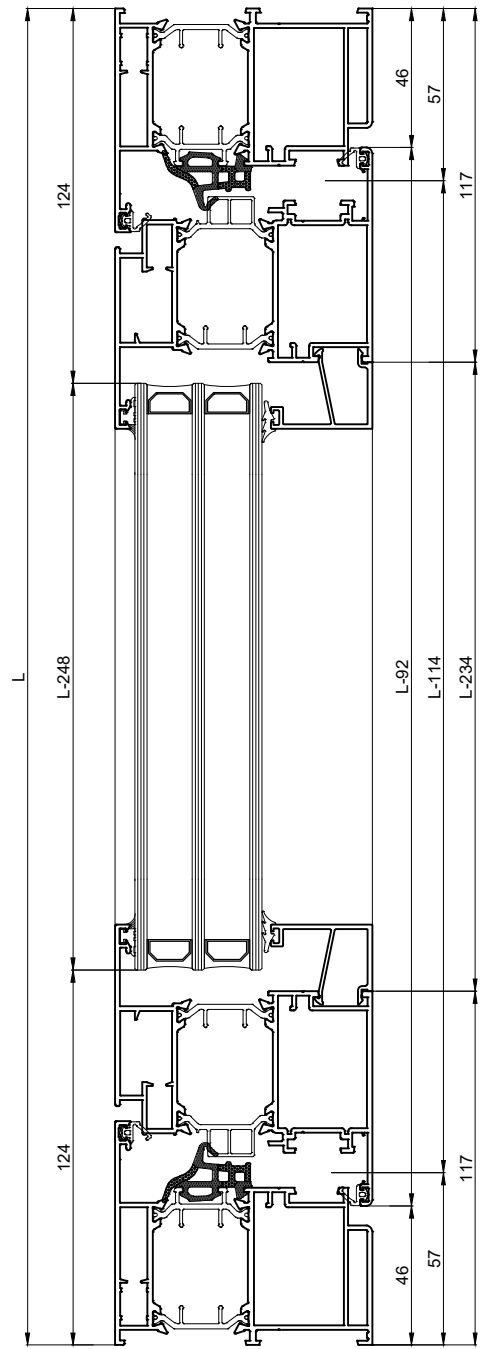
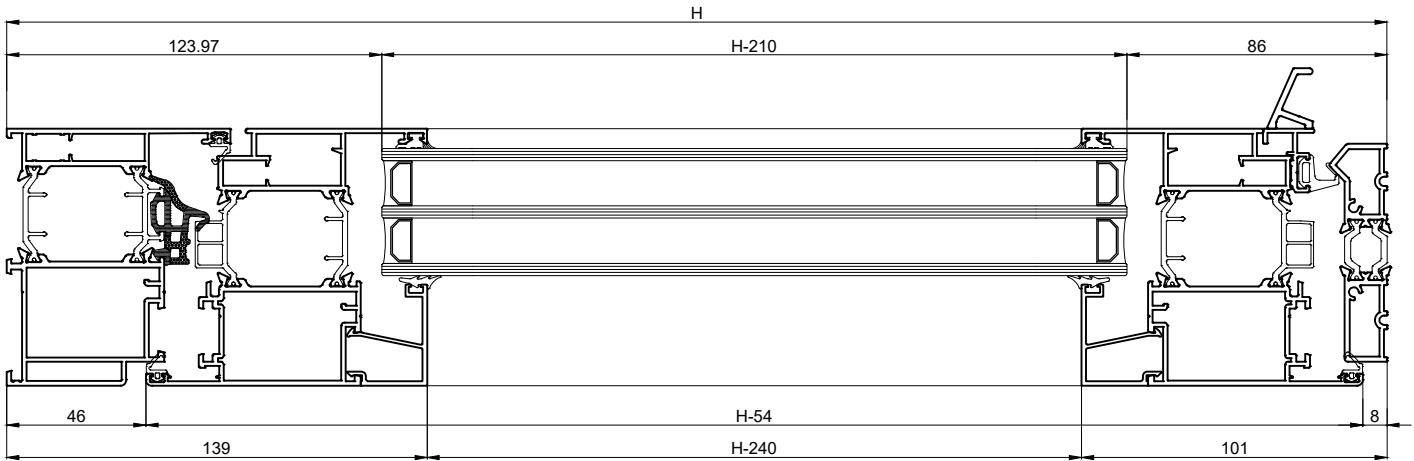

## Rezne liste - Jednokrilna vrata/staklo - Veliki okvir

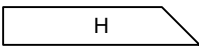
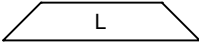
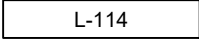
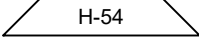
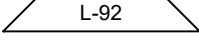
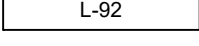
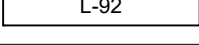
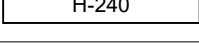
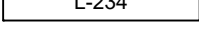
KOD	PROFIL	BR. KOM	REZANJE	KOD	OKOVI	BR. KOM	NOTE
PE 85206	OKOMICA OKVIRA	1L 1D		TONALE 5043	KUTNIK OKVIRA/KRILA	6	
PE 85206	GORNJA VODORAVNICA OKVIRA	1		PRA 02	KUTNIK PORAVNANJA OKVIRA/KRILA	6	
PE 85241	PRAG	1		PRA 203	KUTNIK PORAVNANJA KRILA/OKVIRA	6	
PE 85214	OKOMICA KRILA	1L 1D		PRA 14	KUTNIK PORAVNANJA KRILA/OKVIRA	6	
PE 85214	VODORAVNICA KRILA	2		VILM	VIJAK ZA 5043	12	
PR 58538	NOSAČ BRTVE	1		0092	BOLCNA ZA PRA203	12	
PR 58543	OKAPNICA	1					
-	OKOMITA LAJSNA	2					
-	VODORAVNA LAJSNA	2					

KOD	BRTVE/ČEPOVI	BR. KOM	NOTE
PRG101-PR	CENTRALNA BRTVA	3	1L + 2H
PRA91-PR	KUTNIK CENTRALNE BRTVE	2	-
PRG05-PR	UNUTARNJA BRTVA KRILA	7	3L + 4H
PRG 21	BRTVA PRAGA	1	L
PRG -	VANJSKA BRTVA STAKLA	2	2L + 2H
PRG -	UNUTARNJA BRTVA STAKLA	2	2L + 2H

GORNJA STAKLA		DONJA STAKLA	
(L-248) x (H-210)	1		

Rezne liste - Jednokrilna vrata s panelom - Veliki okvir

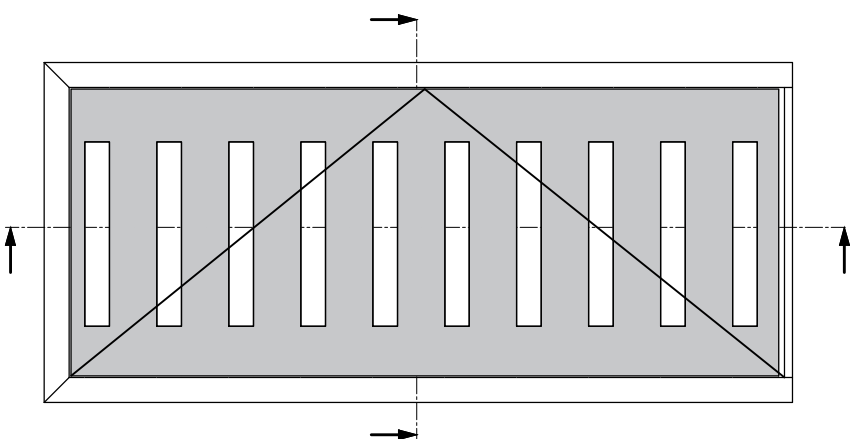
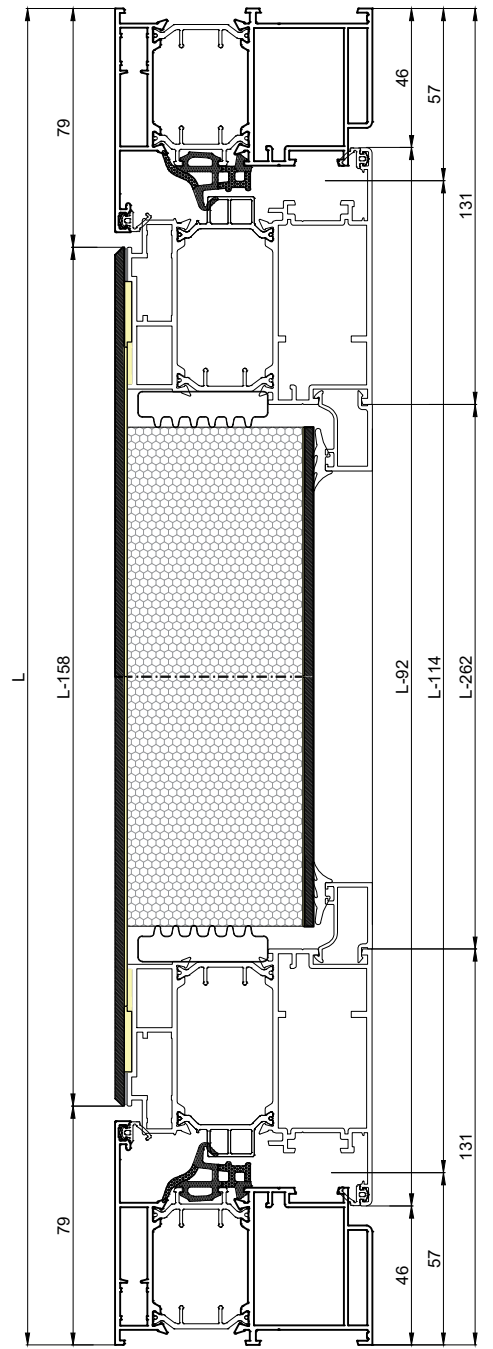
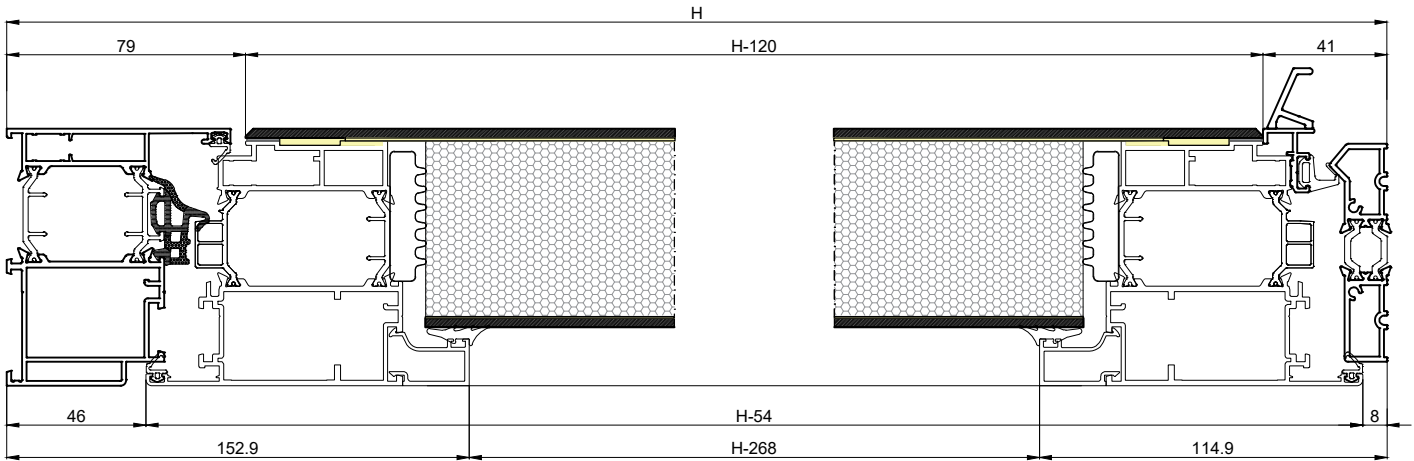

**Rezne liste - Jednokrilna vrata - Veliki okvir**

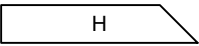
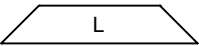
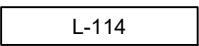
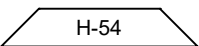
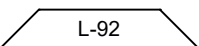
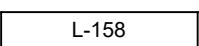
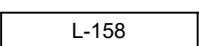
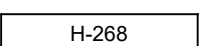
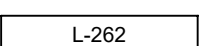
KOD	PROFIL	BR. KOM	REZANJE	KOD	OKOVI	BR. KOM	NOTE
PE 85206	OKOMICA OKVIRA	1L 1D		TONALE 5043	KUTNIK OKVIRA	2	
PE 85206	GORNJA VODORAVNICA OKVIRA	1		PRA 204	KUTNIK KRILA	4	
PE 85241	PRAG	1		PRA 02	KUTNIK PORAVNANJA OKVIRA/KRILA	2	
PE 85242	OKOMICA KRILA	1L 1D		PRA 203	KUTNIK PORAVNANJA KRILA/OKVIRA	6	
PE 85242	VODORAVNICA KRILA	2		PRA 14	KUTNIK PORAVNANJA KRILA/OKVIRA	6	
PR 58538	NOSAČ BRTVE			0126	KUTNIK PORAVNANJA KRILA	4	
PR 58543	OKAPNICA	1		VILM	VIJAK ZA 5043/PRA204	12	
-	OKOMITA LAJSNA	2		0092	BOLCNA ZA 0126 i PRA203	12	
-	VODORAVNA LAJSNA	2					

KOD	BRTVE/ČEPOVI	BR. KOM	NOTE
PRG101-PR	CENTRALNA BRTVA	3	1L + 2H
PRA91-PR	KUTNIK CENTRALNE BRTVE	2	-
PRG05-PR	UNUTARNJA BRTVA KRILA	7	3L + 4H
PRG 21	BRTVA PRAGA	1	L
PRG -	VANJSKA BRTVA STAKLA	2	2L + 2H
PRG -	UNUTARNJA BRTVA STAKLA	2	2L + 2H

VANJSKI PANEL		UNUTARNJI PANEL	
(L-158) x (H-120)	1	(L-277) x (H-239)	1



Obrada na profilu PE85110 i PE85139 za montiranje kutnika PRA200 i PRA 203

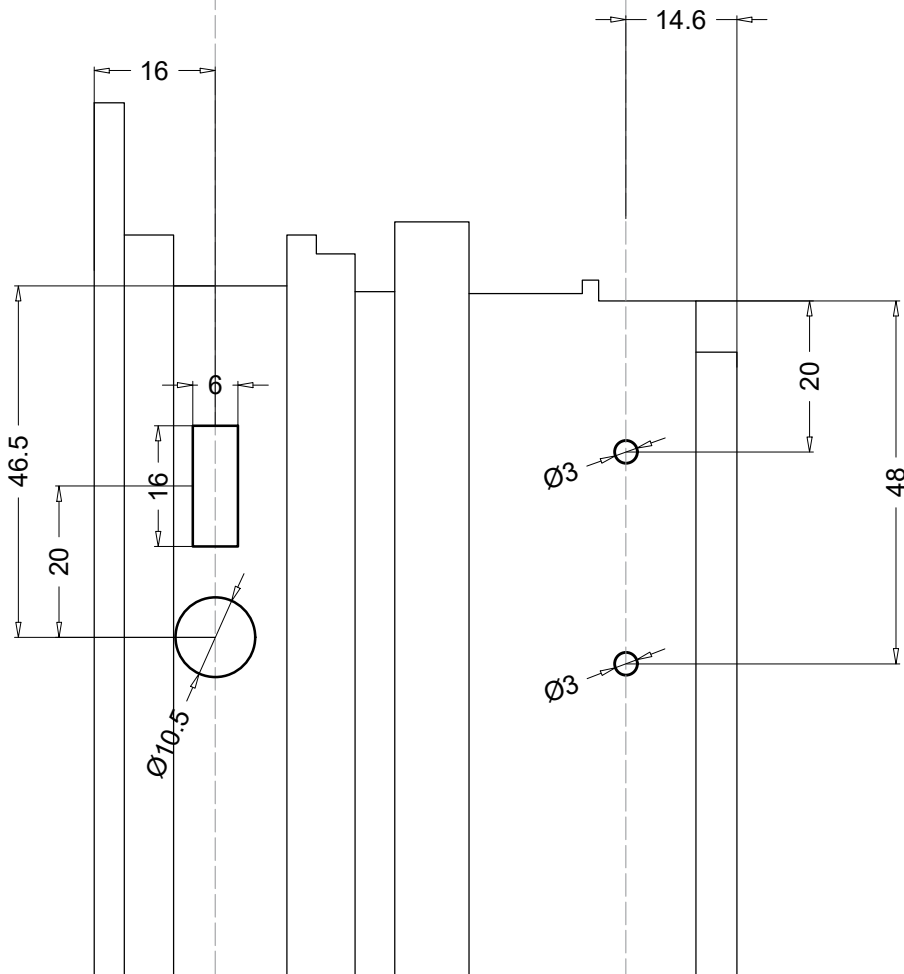
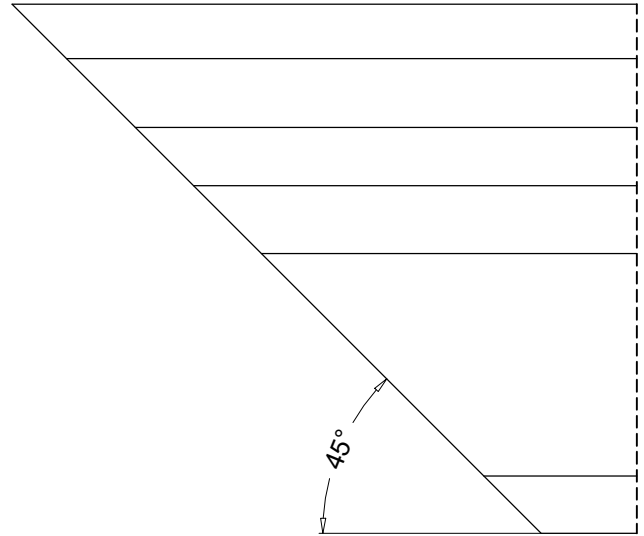
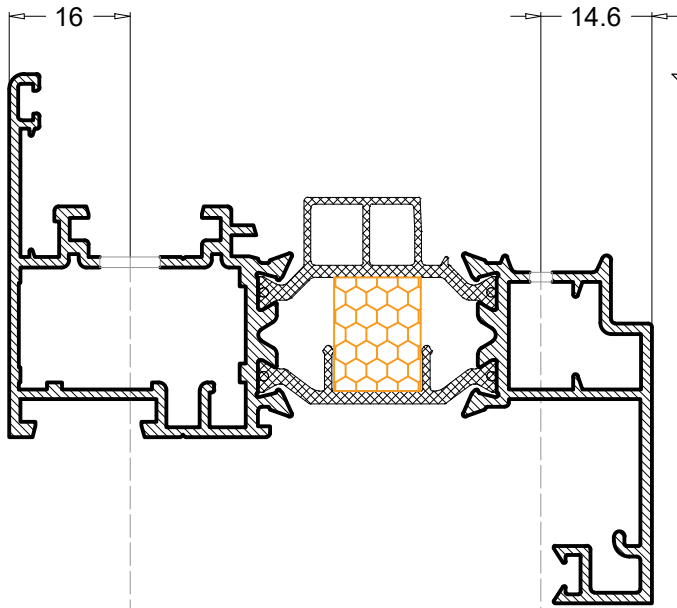

Obrada na profilu PE85202 za montiranje kutnika 5004 i PRA 203

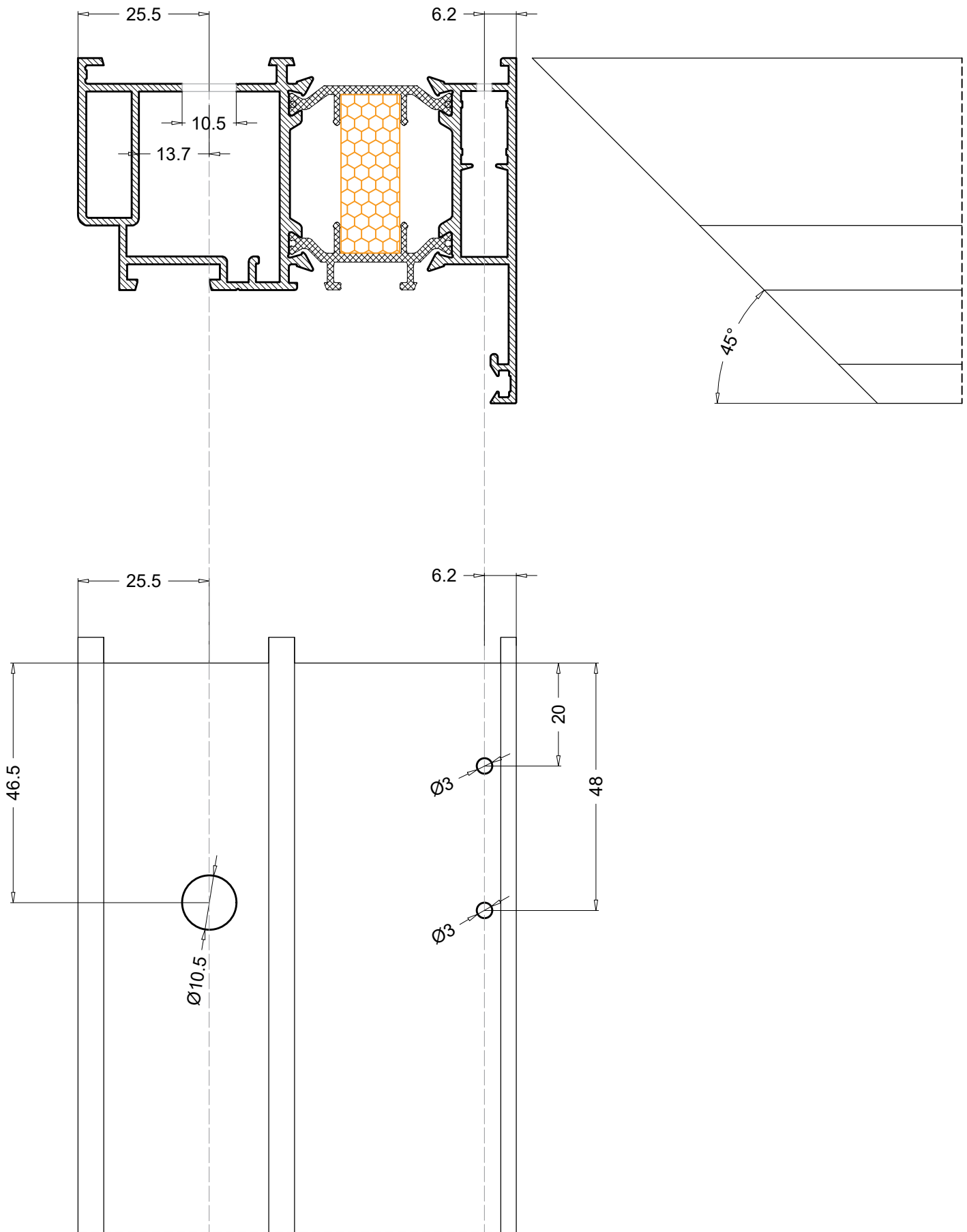

Obrada na profilu PE85206 za montiranje kutnika 5043 i PRA 203

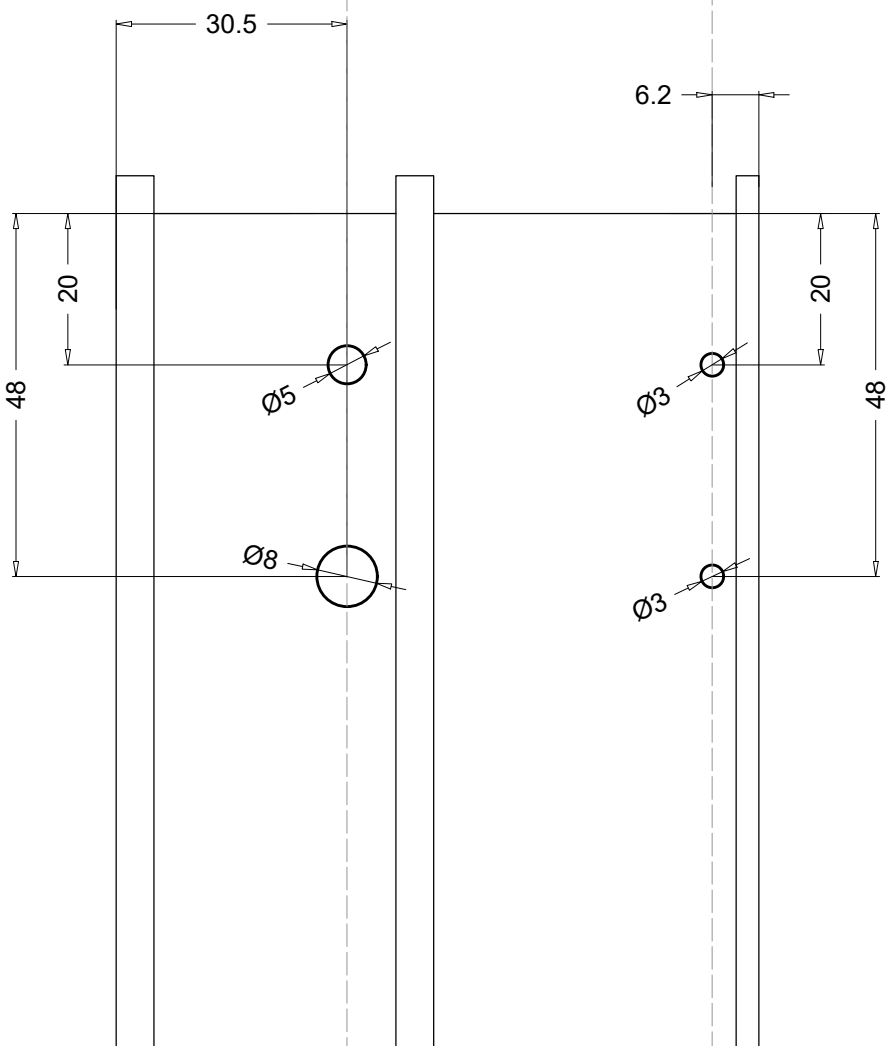
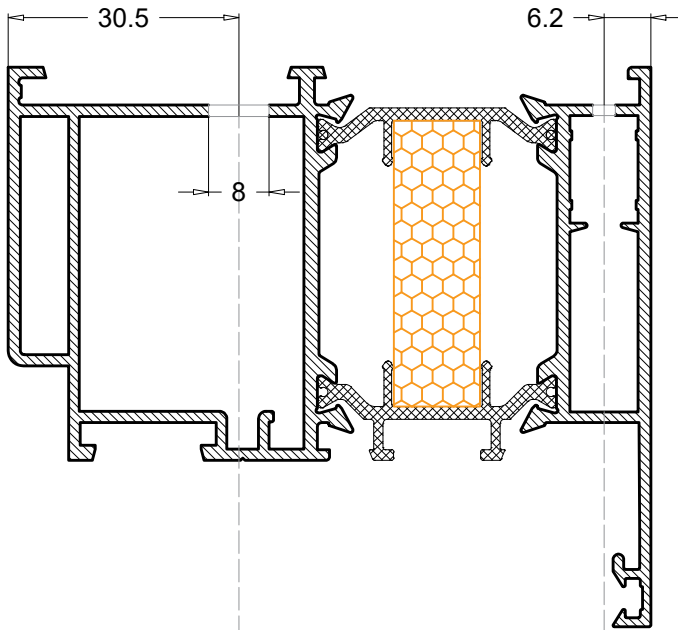

Obrada na profilu PE85242 za montiranje kutnika PRA204 i 0126

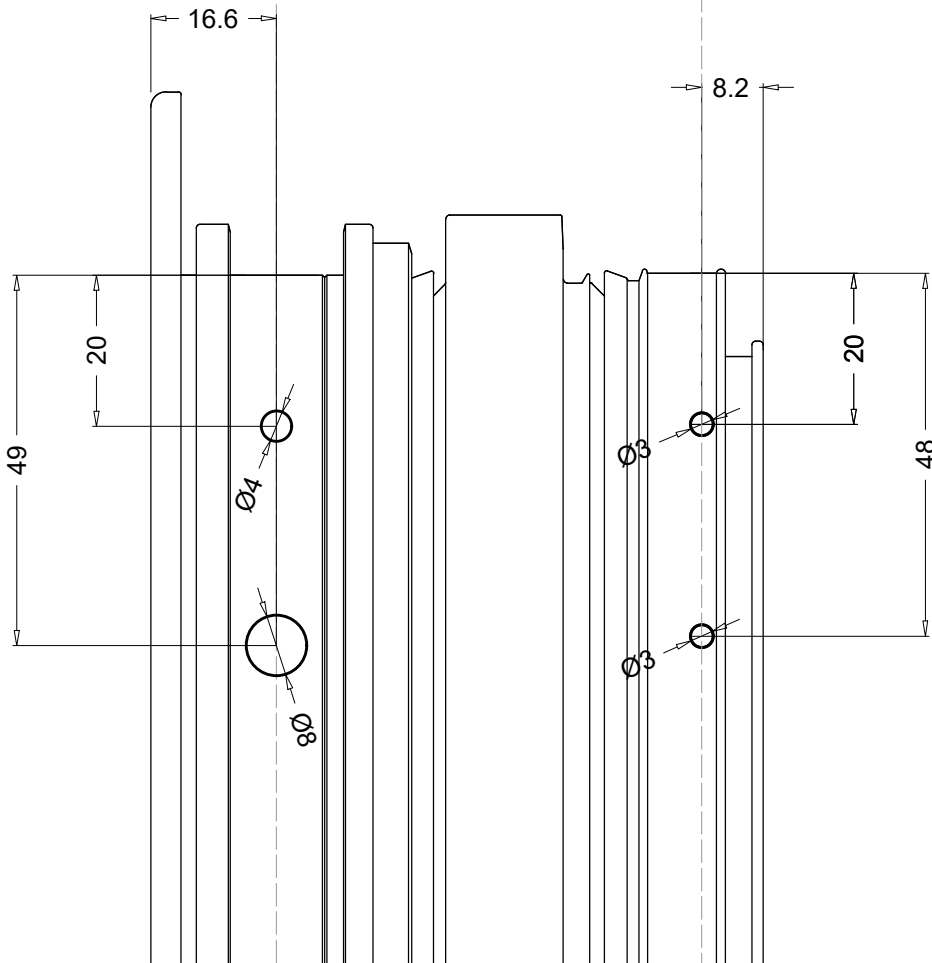
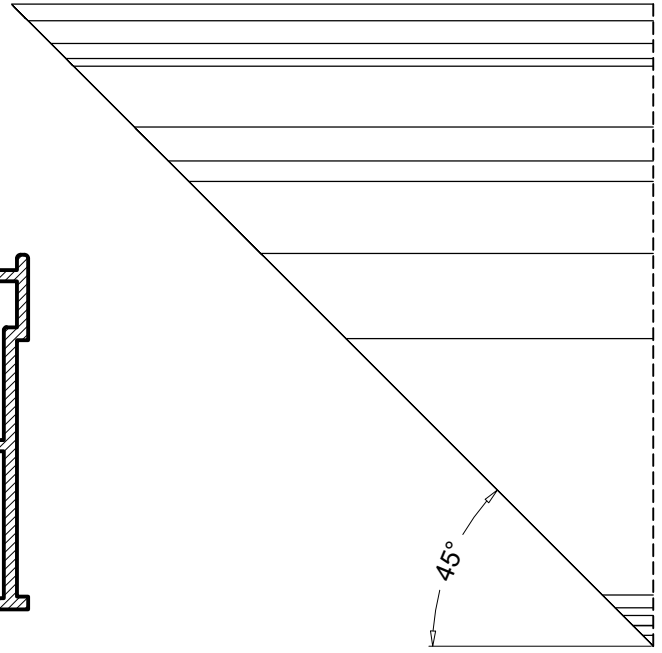
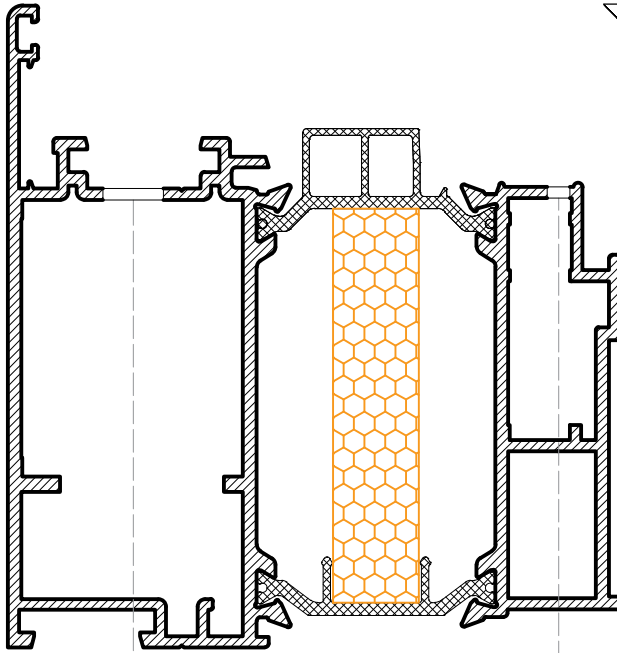

Obrada na profilu klizača PR50550

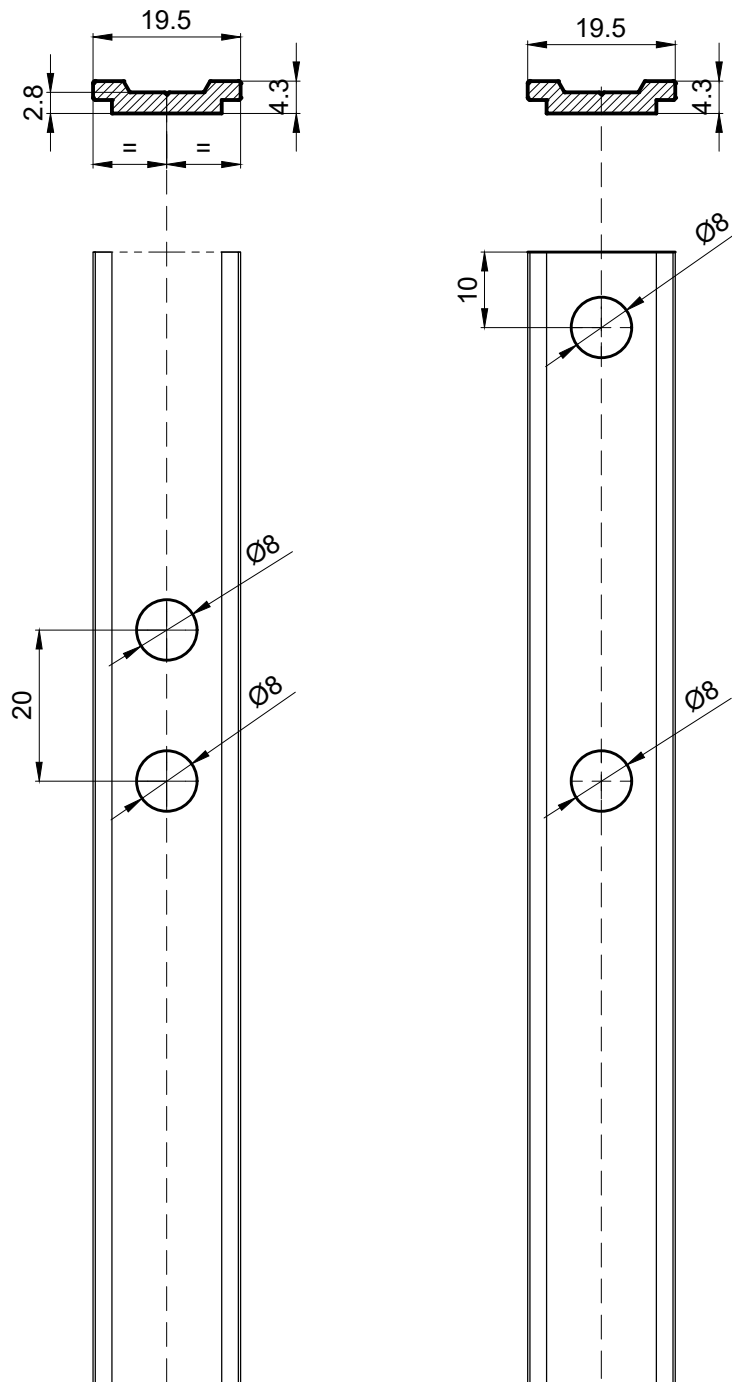

Obrada na profilu okvira za odvod kondenza

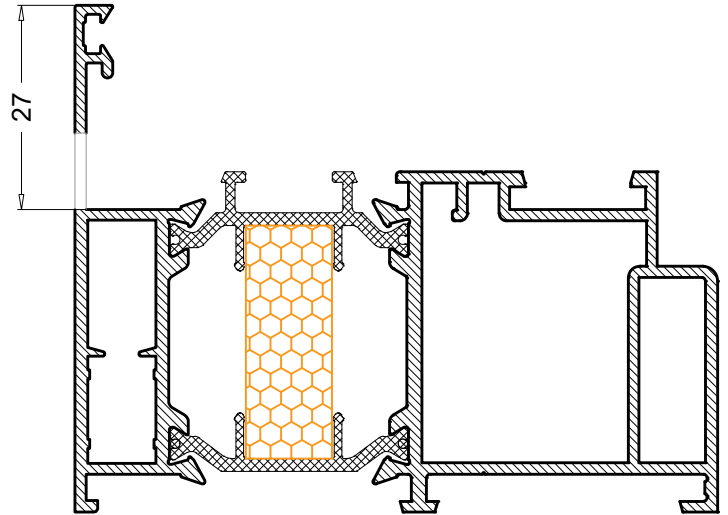
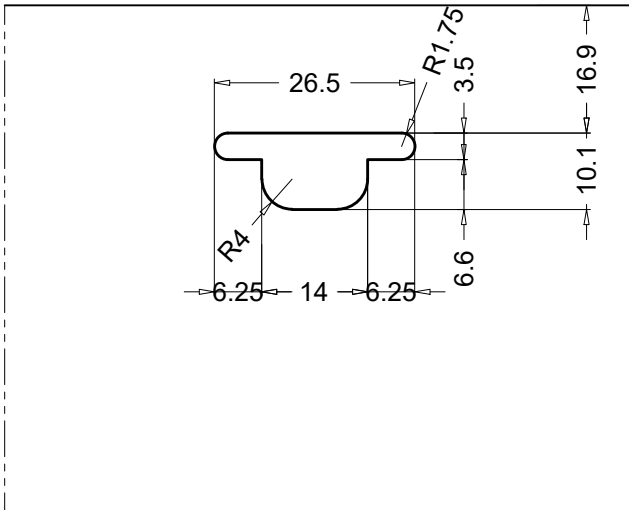

Obrada na profilu okvira za spajanje s pragom

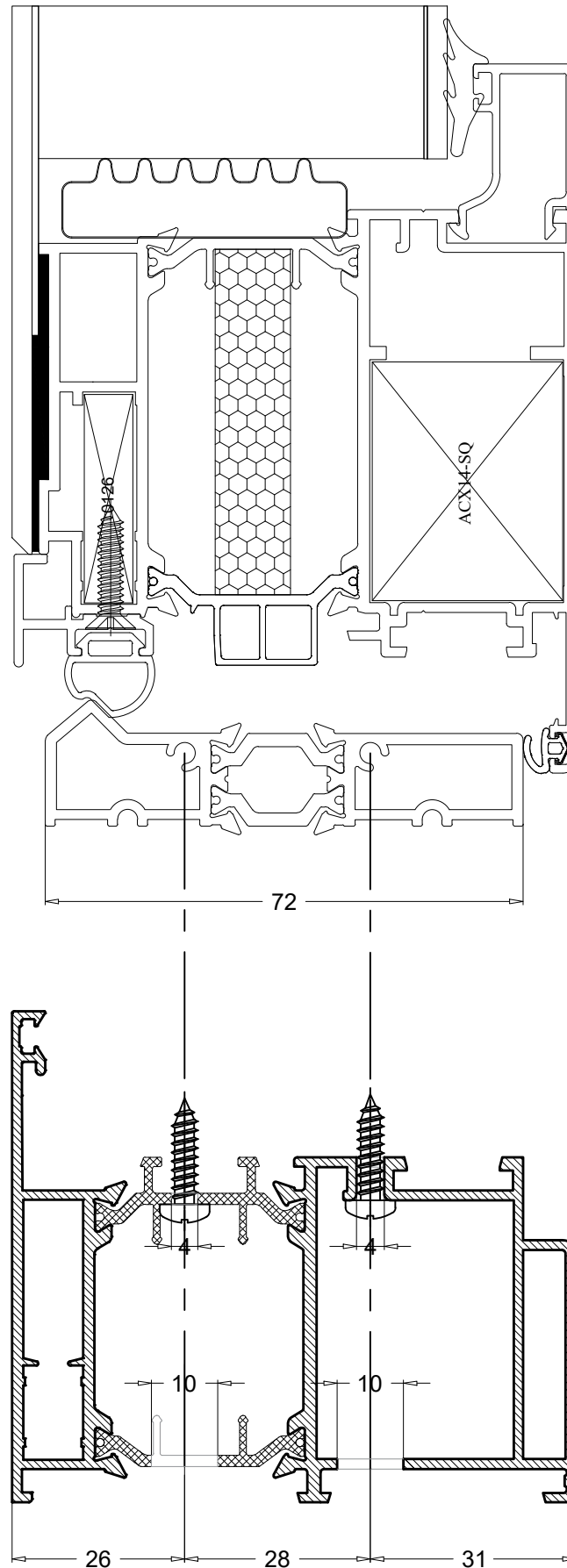

Obrada na profilu PE85235 za spajanje s okvirom

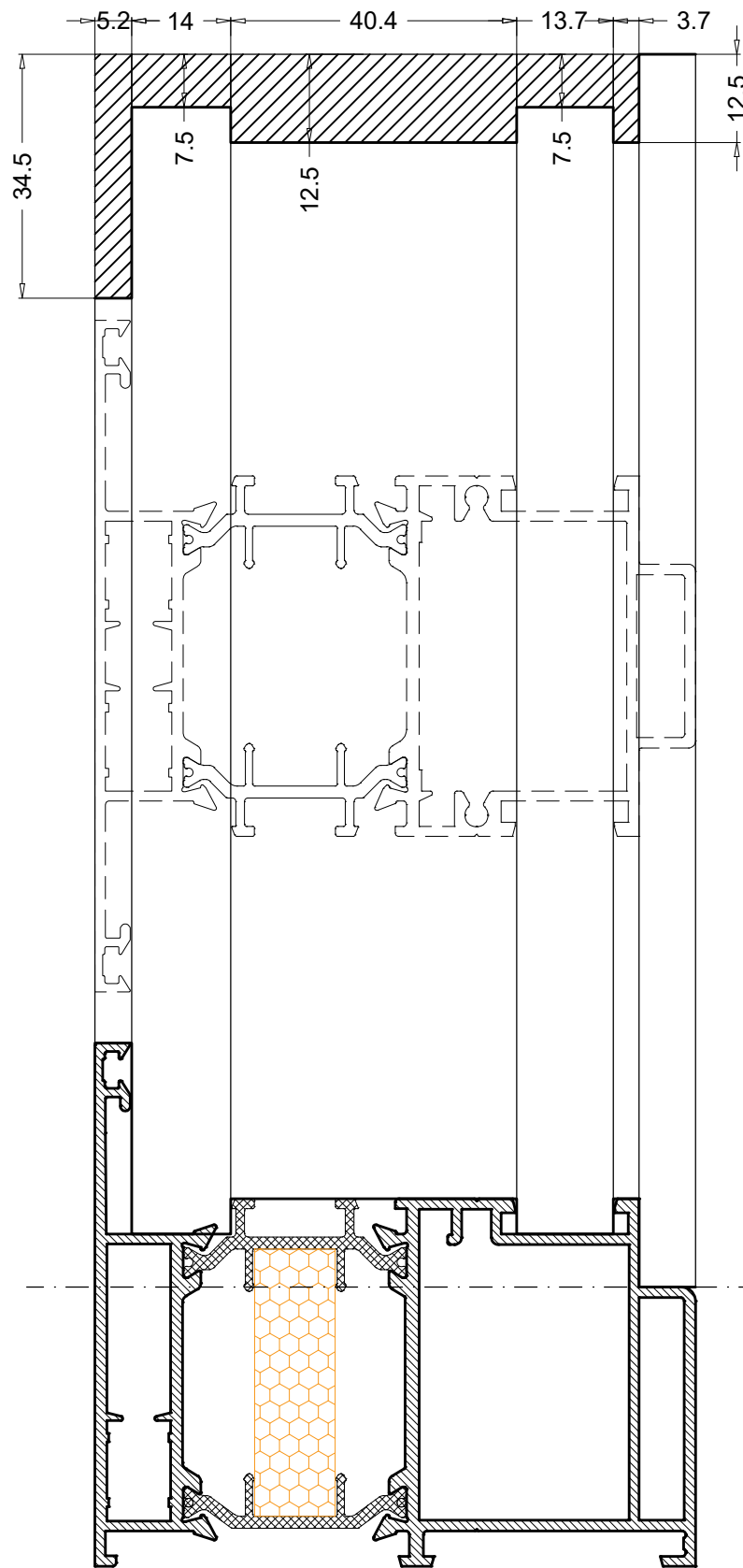

PE85235

PE85206





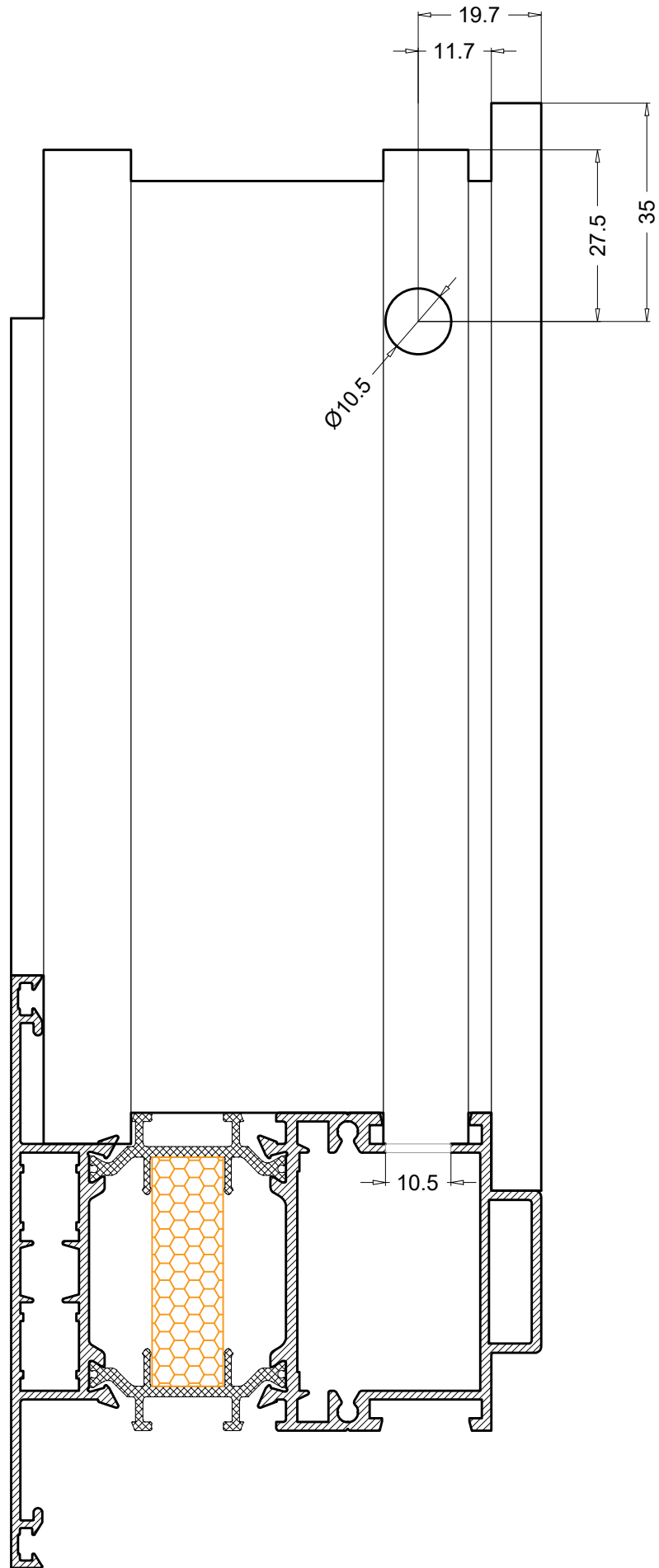



Obrada na profilu PE85235 za spajanje veznikom G123



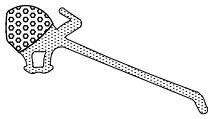

## OKOVI

Code Kod	Section Presjek	Description Opis	Box Quantity Količina/pak.			Material Materijal		
PRG101-PR		Centralna brtva Central gasket	60			EPDM + ESPANSO		
PRA91-54		Kutnik centralne brtve PRG101 Corner joint for central gasket PRG101	60 (komada)			EPDM		
UP2		Unutarnja brtva za staklo,2mm Internal glass gasket,2mm	180			EPDM		
PRG621		Unutarnja brtva za staklo,2-3mm Internal glass gasket,2-3mm	160			EPDM		
UP4		Unutarnja brtva za staklo,4mm Internal glass gasket,4mm	???			EPDM		
PRG14		Unutarnja brtva za staklo, 4-5mm Internal glass gasket, 4-5 mm	120			EPDM		
PRG705		Unutarnja brtva za staklo, 4-5 mm Internal glass gasket, 4-5 mm	150			EPDM		
PRG17		Unutarnja brtva za staklo, 6-7 mm Internal glass gasket, 6-7 mm	80			EPDM		

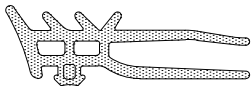

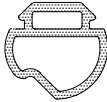
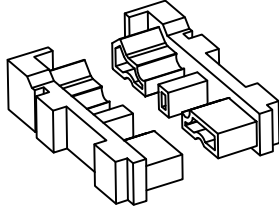

## OKOVI

Code Kod	Section Presjek	Description Opis	Box Quantity Količina/pak.			Material Materijal		
PRG602		Vanjska koesktrudirana brtva za staklo, 2 mm External coextruded glass gasket, 2 mm	350			EPDM + ESPANSO		
			E65Stt	E50	E50tt	PR65tt	PE85tt	PK150tt
PRG603		Vanjska koesktrudirana brtva za staklo, 3 mm External coextruded glass gasket, 3 mm	250			EPDM + ESPANSO		
			E65Stt	E50	E50tt	PR65tt	PE85tt	PK150tt
PRG604		Vanjska koesktrudirana brtva za staklo, 3 mm External coextruded glass gasket, 3 mm	200			EPDM + ESPANSO		
			E65Stt	E50	E50tt	PR65tt	PE85tt	PK150tt
PRG610		Vanjska koesktrudirana brtva za staklo, 3 mm External coextruded glass gasket, 3 mm	100			EPDM + ESPANSO		
			E65Stt	E50	E50tt	PR65tt	PE85tt	PK150tt
PRG616		Vanjska brtva za staklo, 2-3 mm External glass gasket, 2-3 mm	???			EPDM		
			E65Stt	E50	E50tt	PR65tt	PE85tt	PK150tt
PRG617		Vanjska brtva za staklo, 3-4 mm External glass gasket, 3-4 mm	???			EPDM		
			E65Stt	E50	E50tt	PR65tt	PE85tt	PK150tt
PRG618		Vanjska brtva za staklo, 4-5 mm External glass gasket, 4-5 mm	150			EPDM		
			E65Stt	E50	E50tt	PR65tt	PE85tt	PK150tt
PRG620		Vanjska brtva za staklo, 5 mm External glass gasket, 5 mm	150			EPDM		
			E65Stt	E50	E50tt	PR65tt	PE85tt	PK150tt

## OKOVI

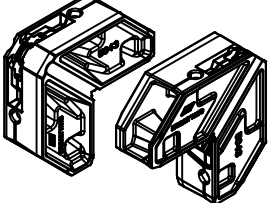
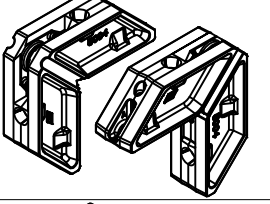
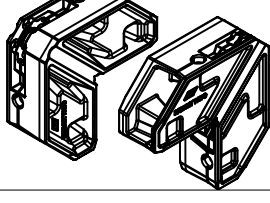
Code Kod	Section Presjek	Description Opis	Box Quantity Količina/pak.					Material Materijal	
PRG05-PR		Udarna EPDM brtva Beating EPDM gasket	200					EPDM	
			E50	E50tt	PR65tt	PE85tt			
PRG05-PR- CO		Udarna koekstrudirana brtva Beating coextruded gasket	240					EPDM + ESPANSO	
			E50	E50tt	PR65tt	PE85tt			
PRG21		Brtva praga PE85241 i PR65241 Threshold gasket for PE85241 and PR65241						EPDM	
						PR65tt	PE85tt		
PRG85		Čep za prag profila PE85241 Threshold plug PE85241						PVC	
							PE85tt		

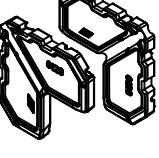
## OKOVI

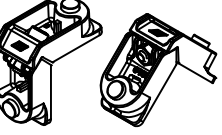
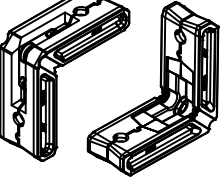
KOD	OPIS	Komada po pakovanju	MATERIJAL				
5043	 <p>Kutnik na vijak za profile PE85206 i PE85342 - komora 29.7 x 39 mm Corner joint on screw for profiles PE85206 and PE85342 - chamber 29.7 x 39 mm</p>						PE85tt
5004	 <p>Kutnik na vijak za profil PE85202 komora 27.3 x 32 mm Corner joint on screw for profile PE85202 - chamber 27.3 x 32 mm</p>						PE85tt
PRA204	 <p>Kutnik na vijak za profile PE85242 komora 29.2 x 36.6 mm Corner joint on screw for PE85242 chamber 29.2 x 36.6 mm</p>						PE85tt
VILM 5x14_D8	 <p>Vijak za kutnike PRA204,5011,5034 i 5043 Screw for corners PRA204,5011,5034 and 5043</p>		E50	E50tt	PR65tt	PE85N	PK150tt
0126	 <p>Kutnik za komoru 7.9 x 32 mm Corner joint for chamber 7.9 x 32 mm</p>						PE85tt
PRA02	 <p>Kutnik poravnanja 2200 4.8mm x 17.4 mm Alignment corner joint 2200 4.8mm x 17.4 mm</p>		PR65tt	PE66tt	PE75tt	PE85tt	PK150tt
PRA200	 <p>Glavni kutnik krila 0409 28.5 x 14.5 mm Corner joint on button 0409 28.5 x 14.5 mm</p>		PR65tt	PE66tt	PE75tt	PE85tt	PK150tt
5011	 <p>Glavni kutnik krila 5011 28.5 x 14.5 mm Corner joint on screw 0409 28.5 x 14.5 mm</p>		PR65tt	PE66tt	PE75tt	PE85tt	PK150tt

## OKOVI

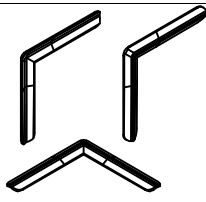
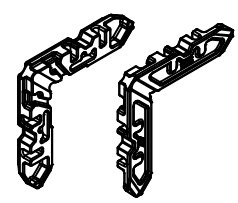
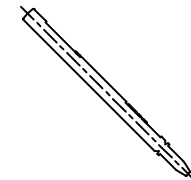
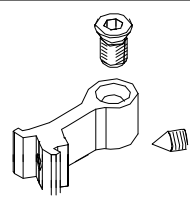
KOD	OPIS	Komada po pakovanju	MATERIJAL					
PRA 14	 <p>Kutnik poravnanja 0707 INOX Alignment corner joint 0707 INOX</p>		Aluminijski odlivak					
			PS50	SO49tt	PR65tt	PE66tt	PE75tt	PE85tt
PRA 203	 <p>Pomoćni kutnik 1105 8.5 x 14.4 mm Alignment corner joint 1105 8.5 x 14.4 mm</p>		Aluminijski odlivak					
							PE85tt	PE85ttN
0092	 <p>Bolcna za spajanje 0092 Connecting pin 0092</p>		Aluminijski odlivak					
					PK150tt	PR65tt	PE85tt	E90tt
G123	 <p>Veznik prečke Crossbar connector</p>		Aluminijski odlivak					
			E50	E50tt	PR65tt	PE85tt	PE85ttN	E90tt

Napomene / Notes



Emerus d.o.o. | A. von Humboldta 4B | 10000 Zagreb | Hrvatska | Tel: +385 1 2099 195

Emerus d.o.o. | Knešpolje b.b. | 88220 Široki Brijeg | Bosna i Hercegovina | Tel: +387 39 701 240

[www.emerus.eu](http://www.emerus.eu)

[info@emerus.eu](mailto:info@emerus.eu)

