



***Presal
Extrusion***

PE 85



LISTA PROFILA

ŠIFRA:	IZGLED – PRESJEK:	TEŽINA gr/m	OPSEG	Ix cm ⁴	Wx cm ³	NAPOMENA:
PE 85105		1,883				
PE 85---		1,923				
PE 85106		1,770				
PE 85157		1,496				
PE 85110		1,602				
PE 85113		1,534				

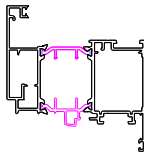
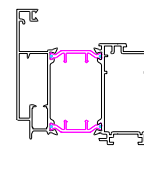
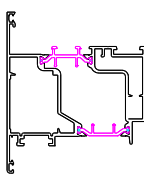
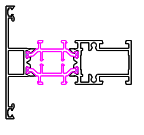
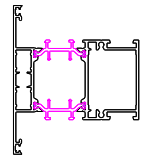
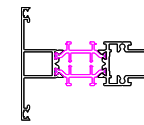
LISTA PROFILA

ŠIFRA:	IZGLED – PRESJEK:	TEŽINA gr/m	OPSEG	Ix cm ⁴	Wx cm ³	NAPOMENA:
PE 85112		2,095				
PE 85114		2,283				
PE 85130		2,431				
PE 85138		1,573				
PE 85135		2,014				
PE 85122		1,654				

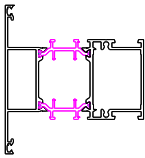
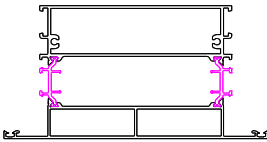
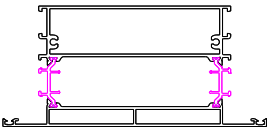
LISTA PROFILA

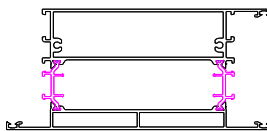
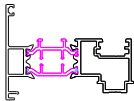
ŠIFRA:	IZGLED – PRESJEK:	TEŽINA gr/m	OPSEG	Ix cm ⁴	Wx cm ³	NAPOMENA:
PE 85124		2,012				
PE 85120		3,517				
PE 85137		3,427				
PE 85121		3,629				
PE 85136		3,539				
PE 85132		1,511				



PROFILI OKVIR NA ZIDU

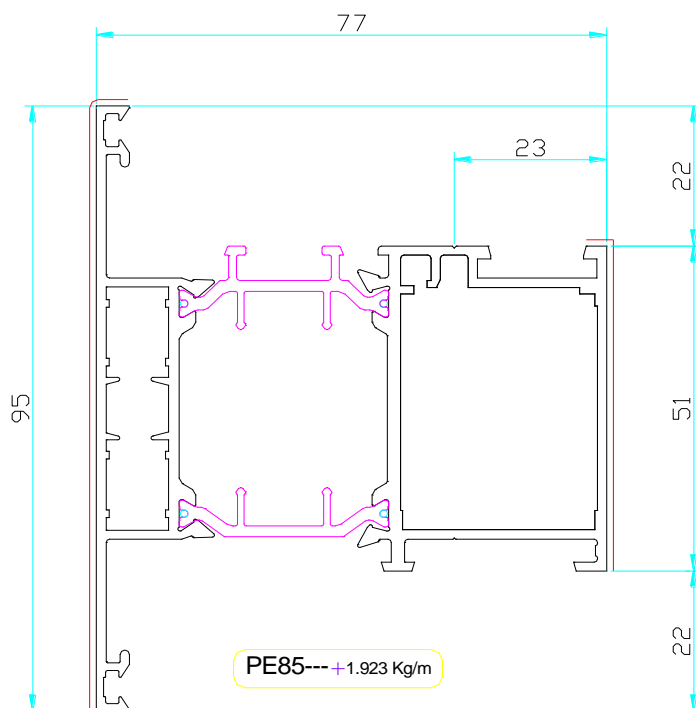
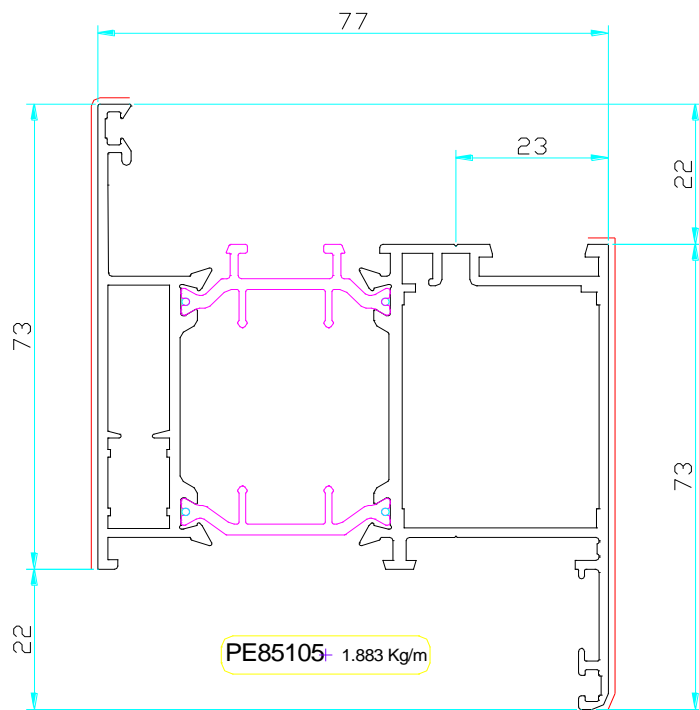



PROFILI OKVIR NA ZIDU

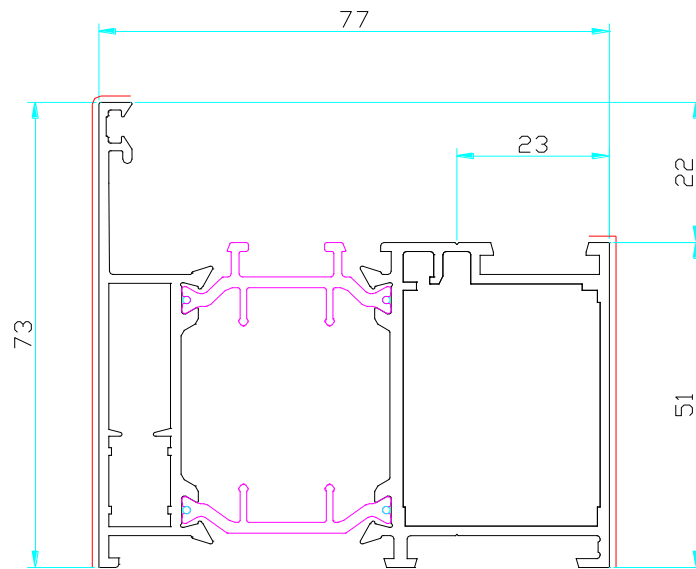

PE85106- 1.770 Kg/m

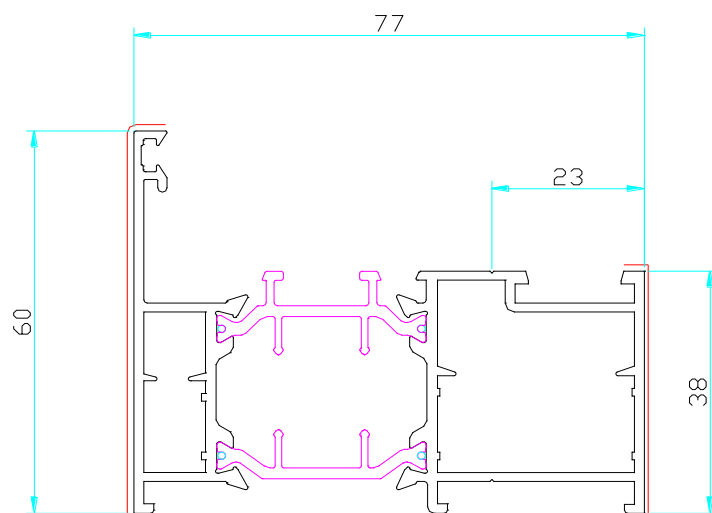

PE85157- 1.496 Kg/m

MJ. 1:1

Sistem PE 85 Profili sa prekinutim termickim mostom

Str. 01

01/10/2016



PROFILI OKVIR NA ZIDU

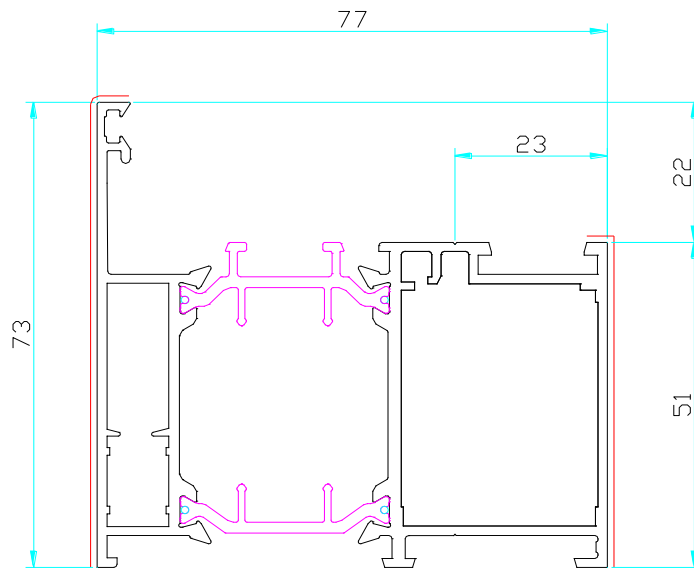

PE85106- 1.770 Kg/m

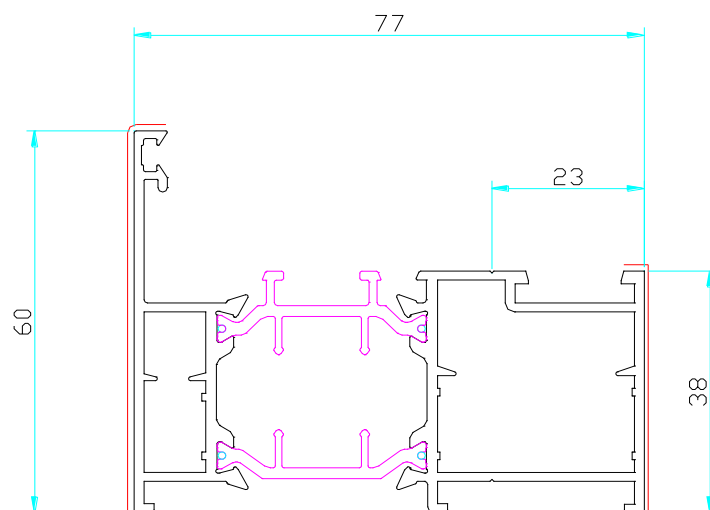

PE85157+ 1.496 Kg/m



PROFILI UDARAJUĆE KRILU NORMALNO OTVARANJE

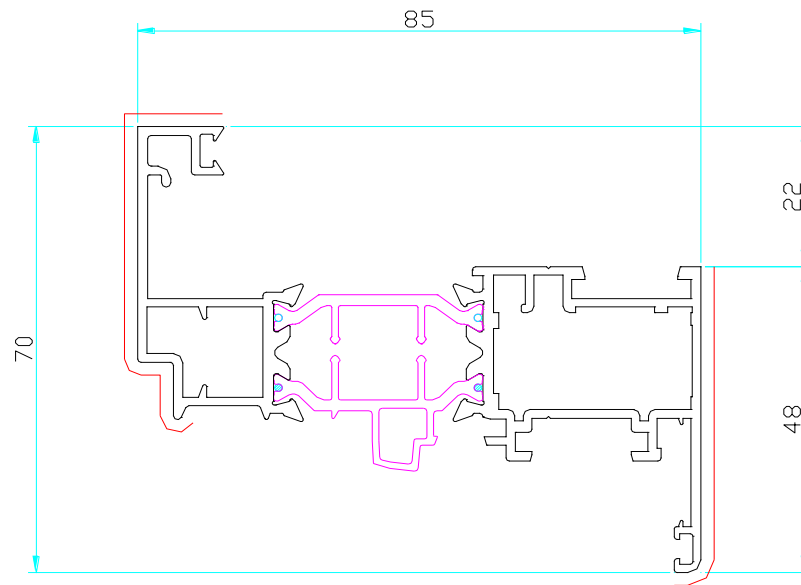

PE85110- 1.602 Kg/m

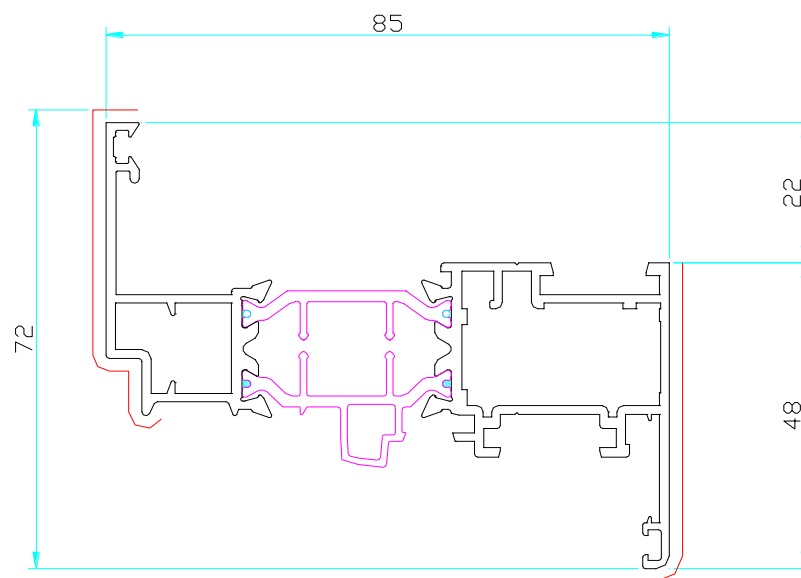

PE85113- 1.534 Kg/m



PROFIL I UDARAJUĆE KRILO NORMALNO OTVARANJE

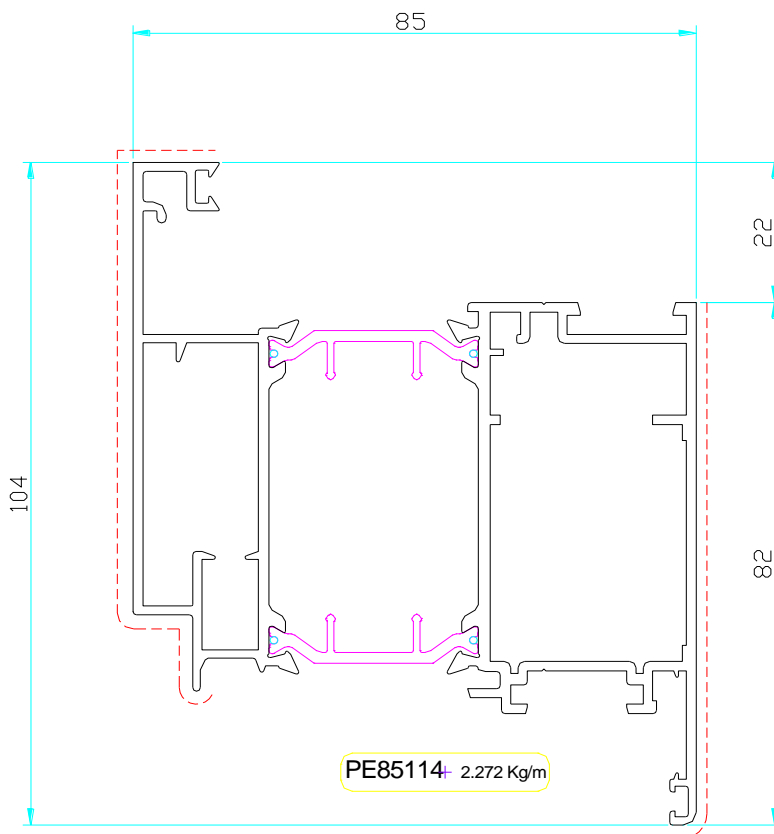
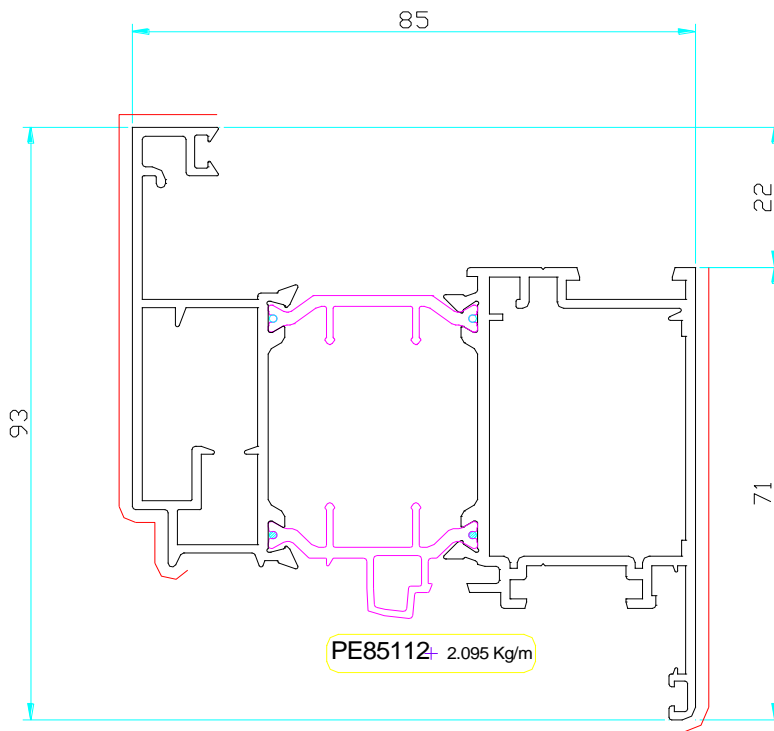

PROFILI UDARAJUÆE KRILO VANJSKO OTVARANJE

PE85 $\frac{1}{2}$ kg/m

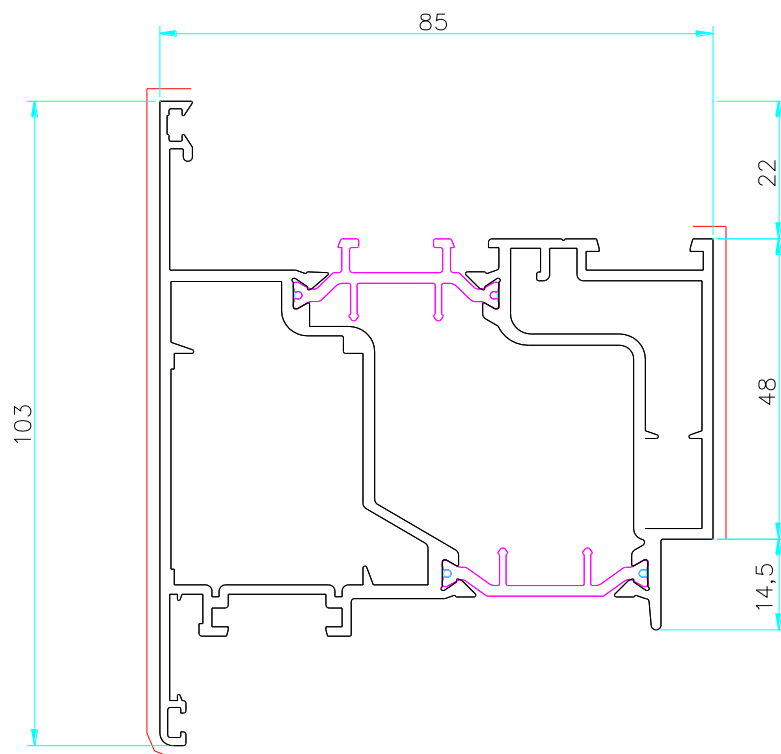

PE85130 $\frac{1}{2}$ 2431 kg/m

PROFILI PREËKA

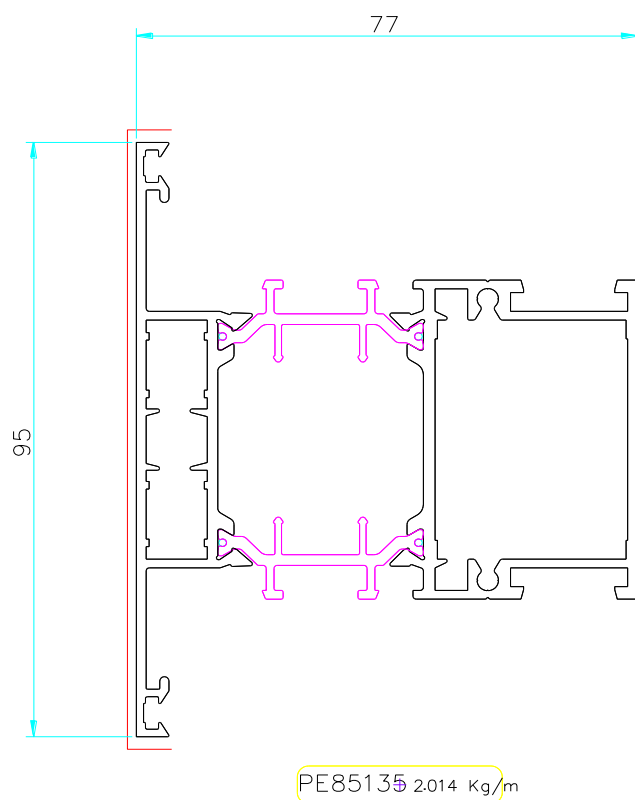
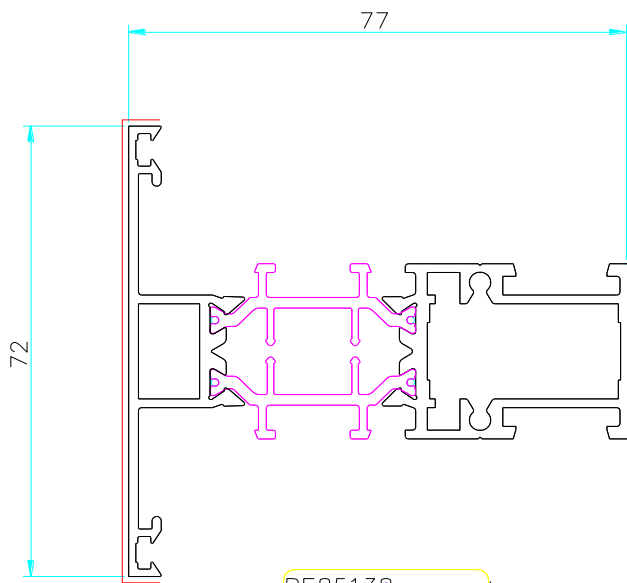

PROFILI PREËKA

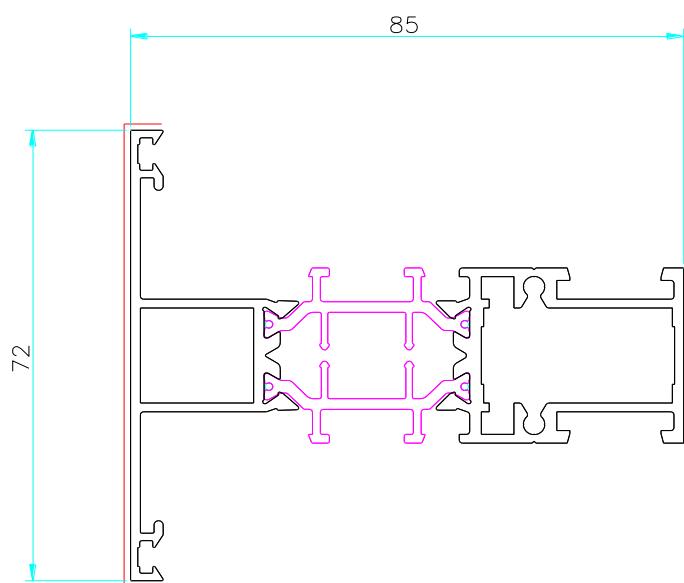

PE85122 1.654 Kg/m

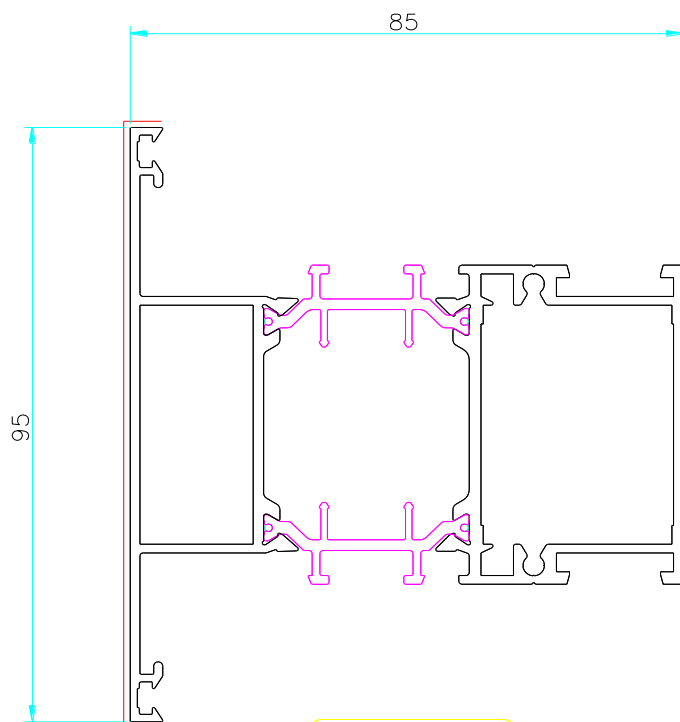

PE85124 2.012 Kg/m

PROFILI PREËKA PARAPETNA

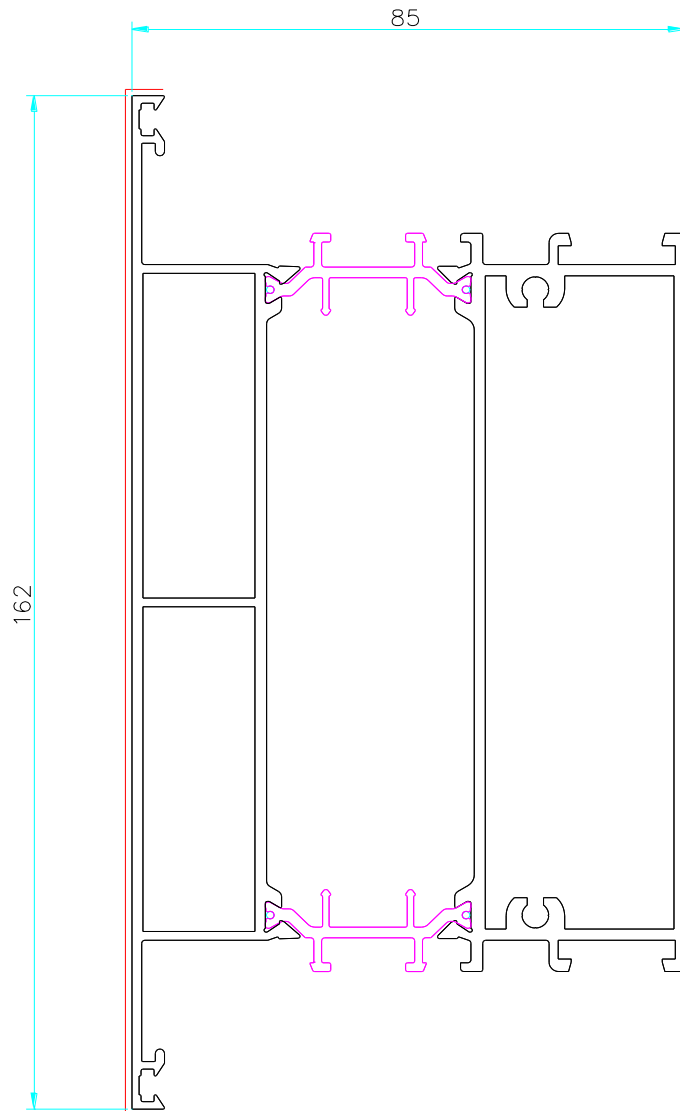

PE85120 3.517 Kg/m

MJ. 1:1

Sistem PE 85 Profili sa prekinutim termičkim mostom

01/10/16

PROFILI PREÈKA PARAPETNA

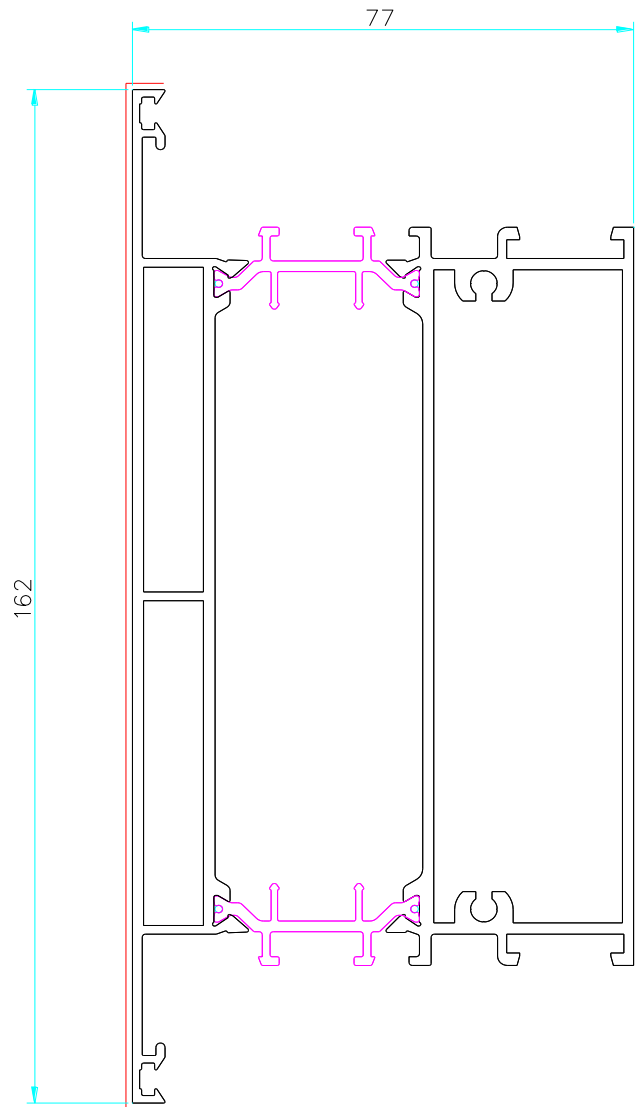

PE85137 3.427 Kg/m

MJ. 1:1

Sistem PE 85 Profili sa prekinutim termièkim m³ 01

01/10/16

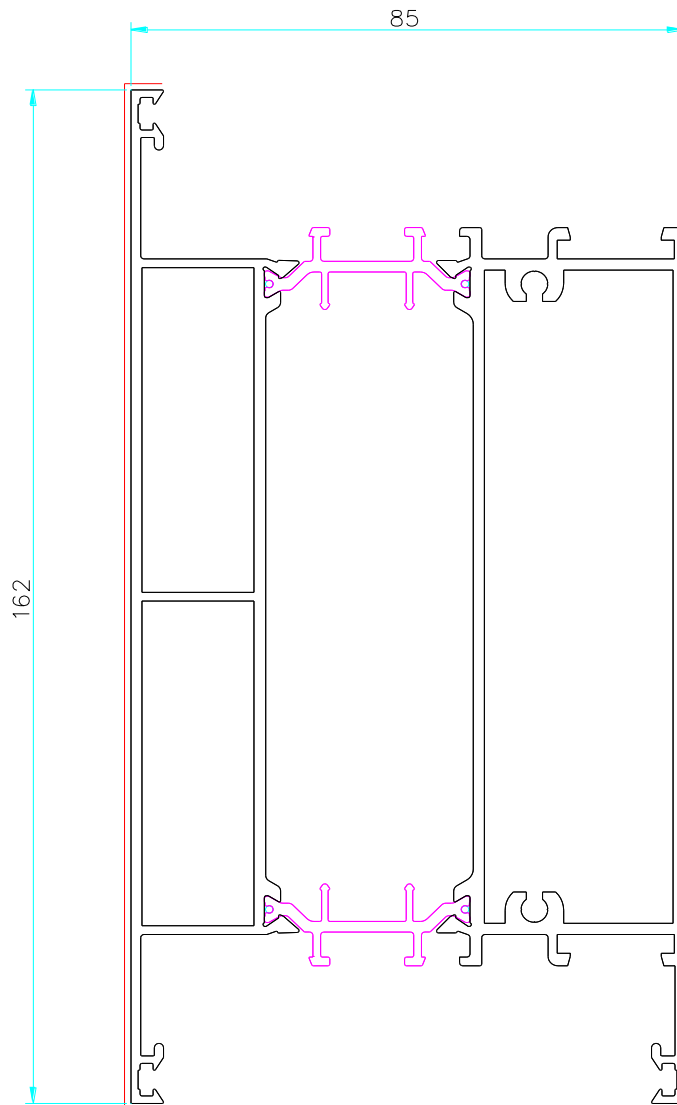

PE8512+ 3.629 Kg/m

PROFILI PARAPETNI PROFIL

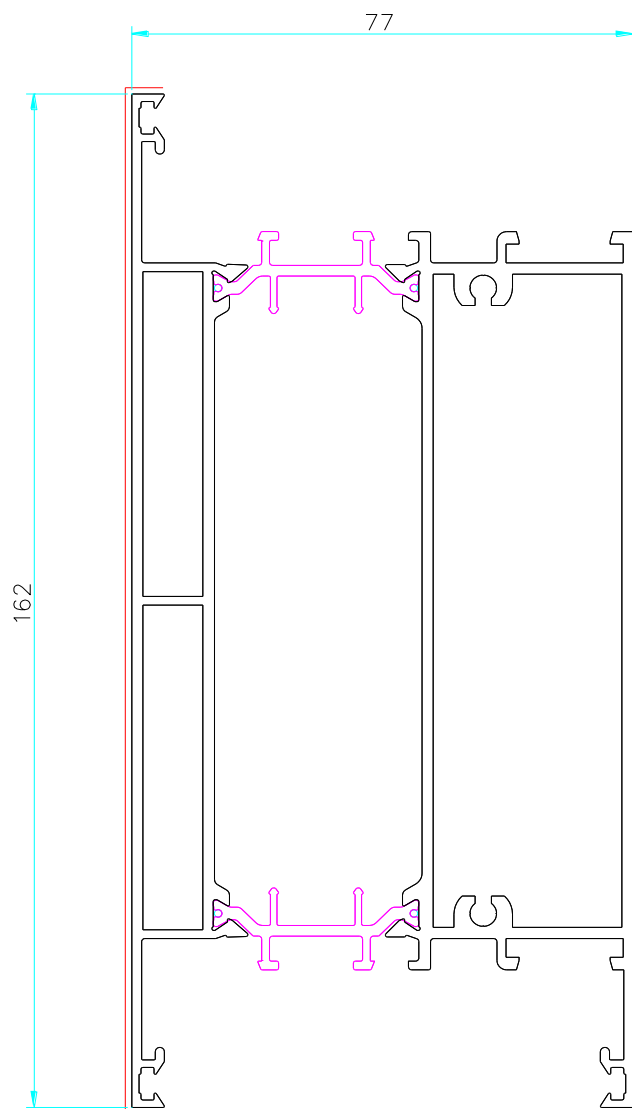

PE85136 3.539 Kg/m

MJ. 1:1

Sistem PE 85 Profili sa prekinutim termičkim mostom

01/10/10

PROFILI UKLOPNI PREKLOPNIK (ŠTULP)

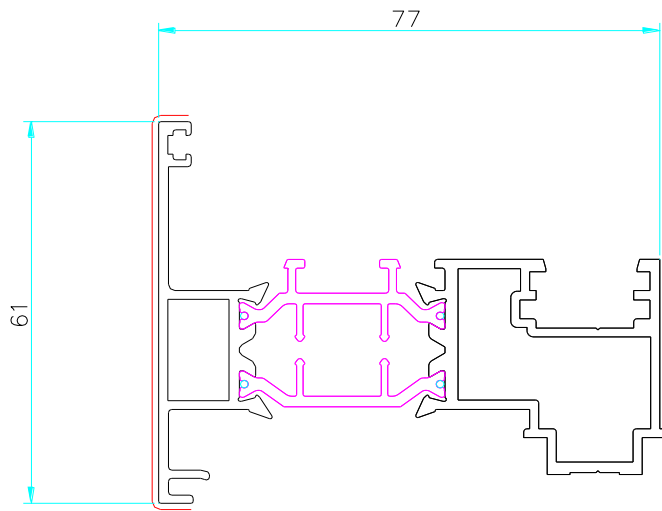

PE85132 1.511 kg/m

+

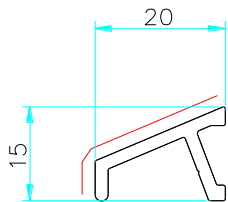

PR58543 0.211 Kg/m

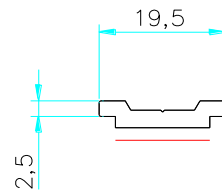

PR50550 0.160 Kg/m

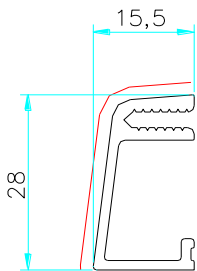

PR58541 0.310 Kg/m

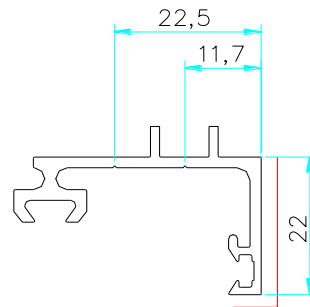

PR58539 0.430 Kg/m

TIPIËNI PRESJECI

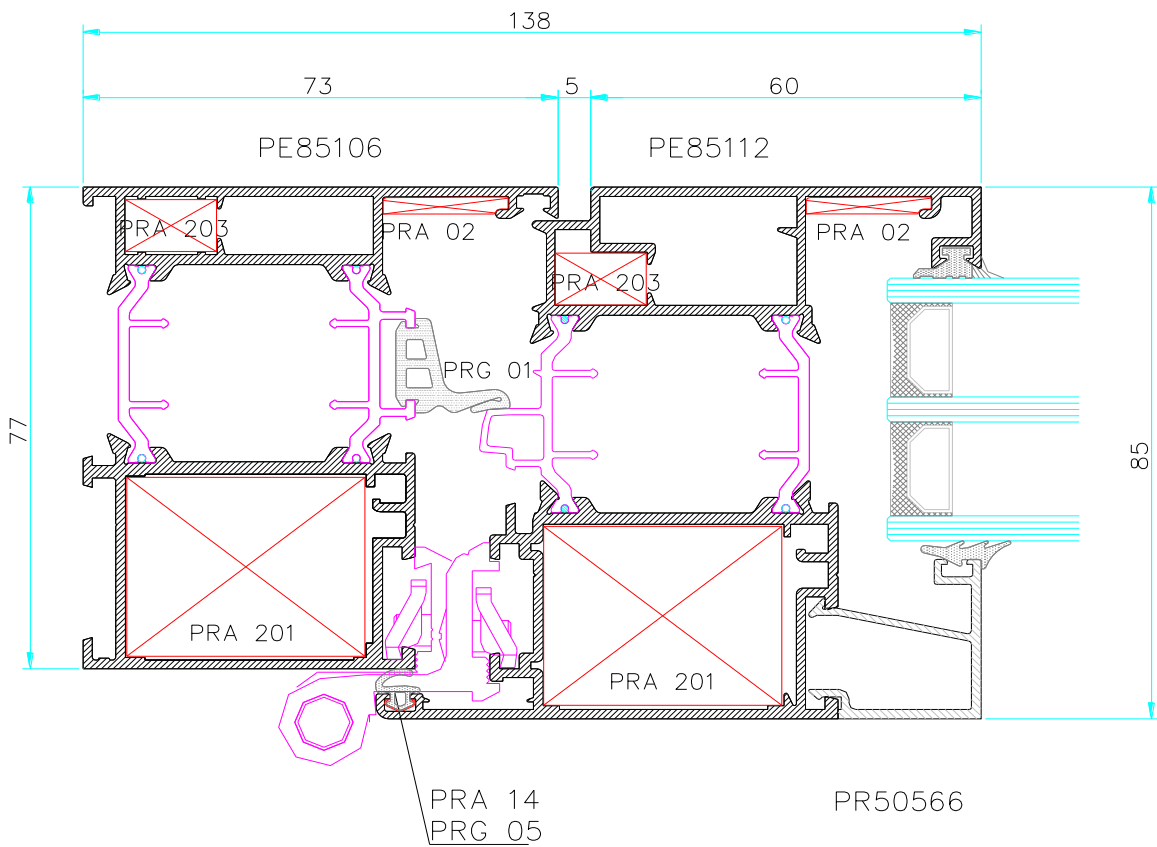
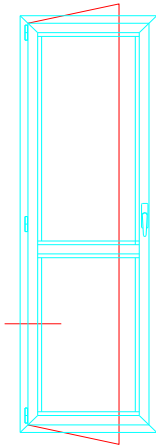

TIPIËNI PRESJECI

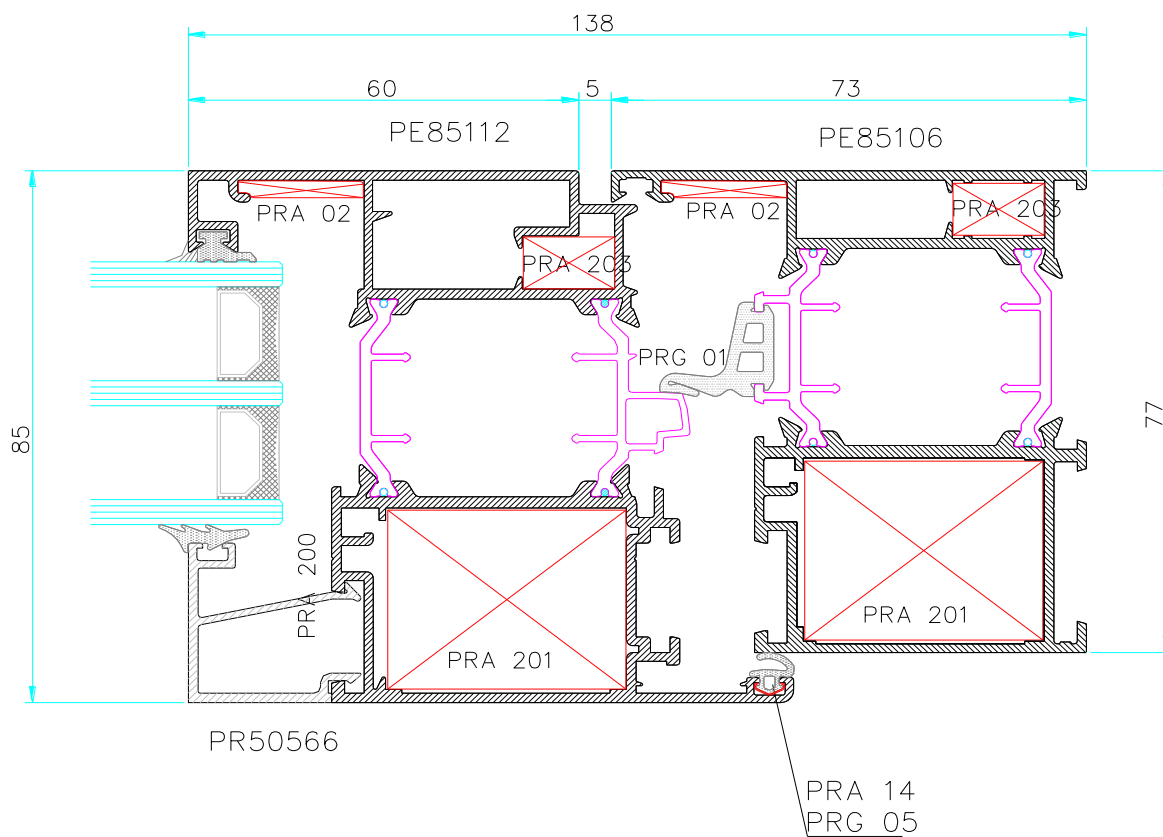
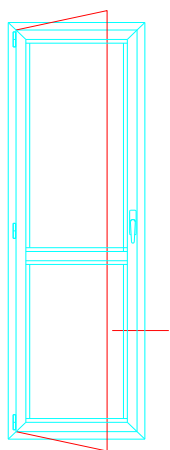

TIPIÈNI PRESJECI

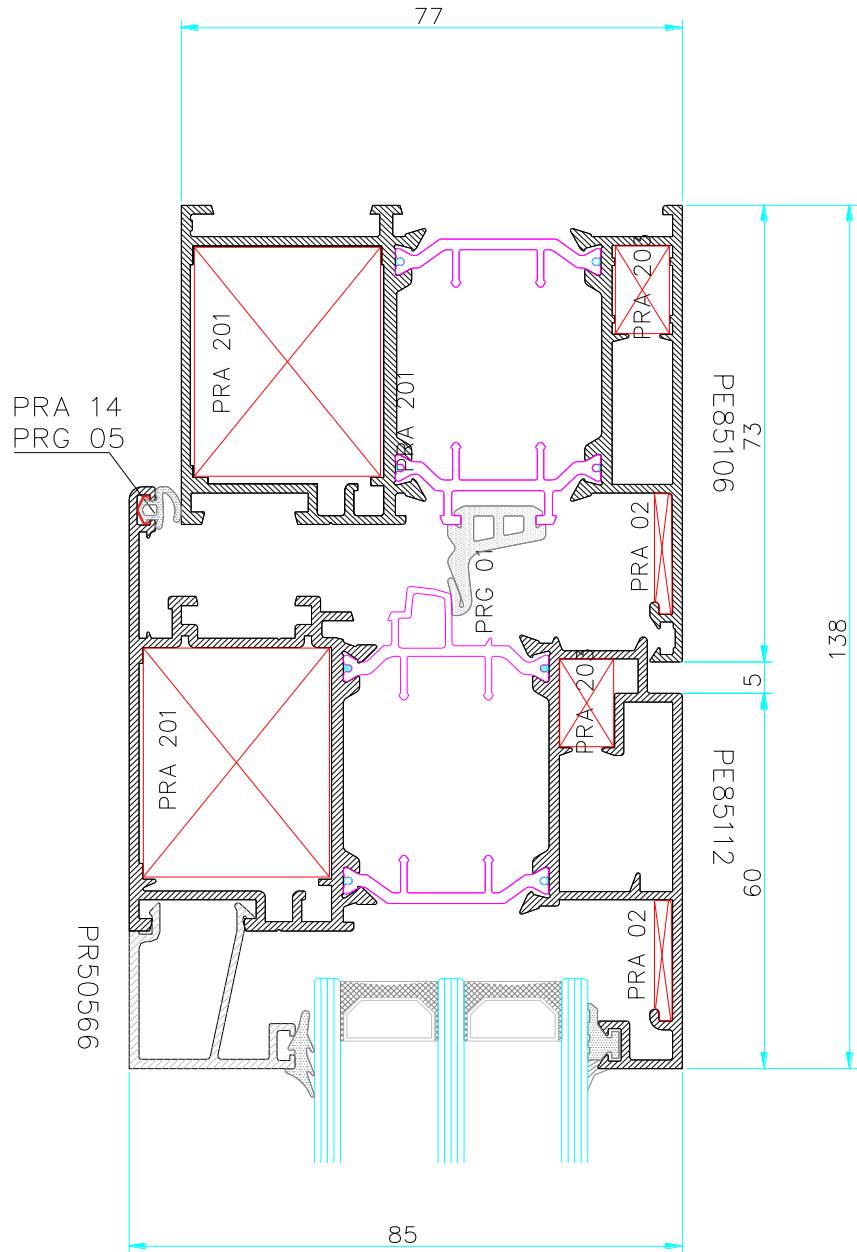
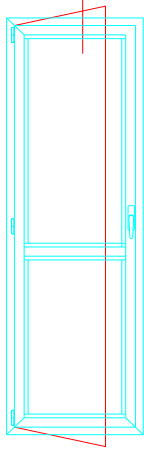

TIPIËNI PRESJECI

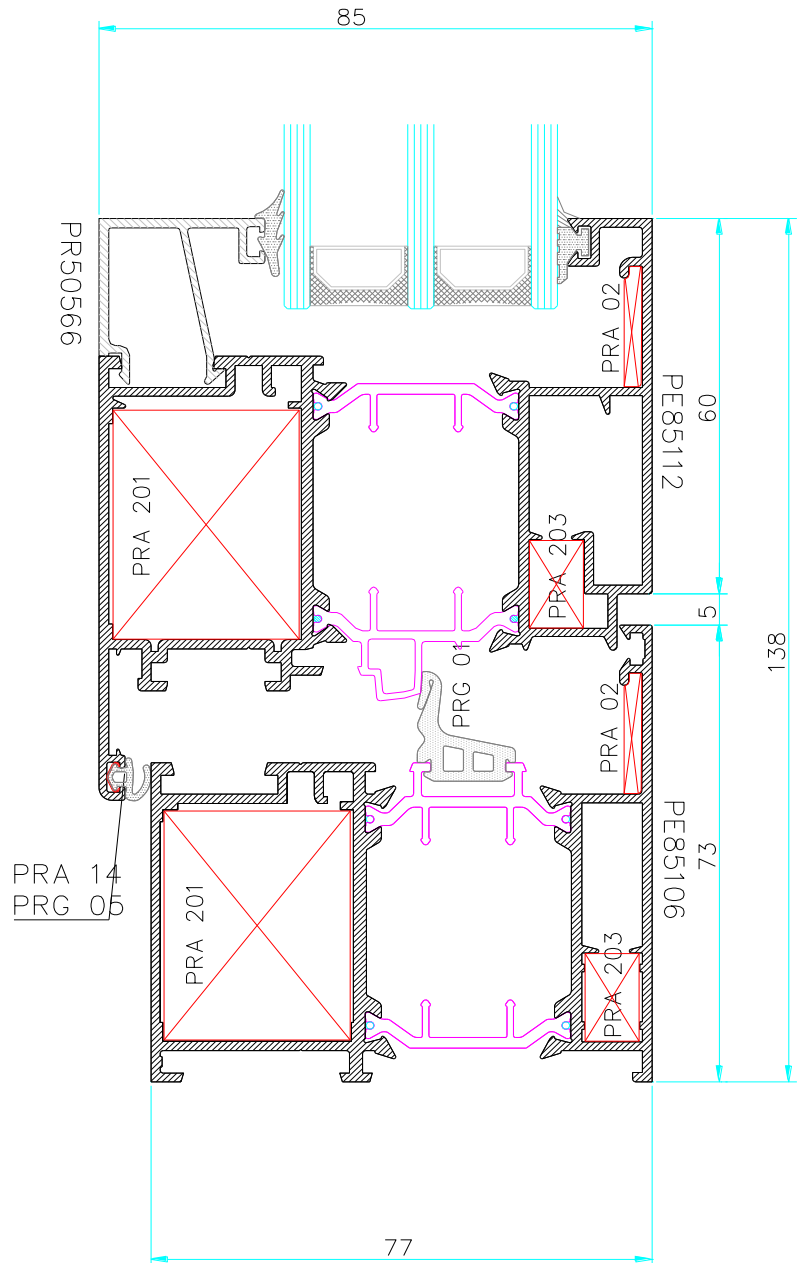
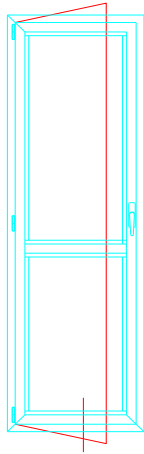

TIPIËNI PRESJECI

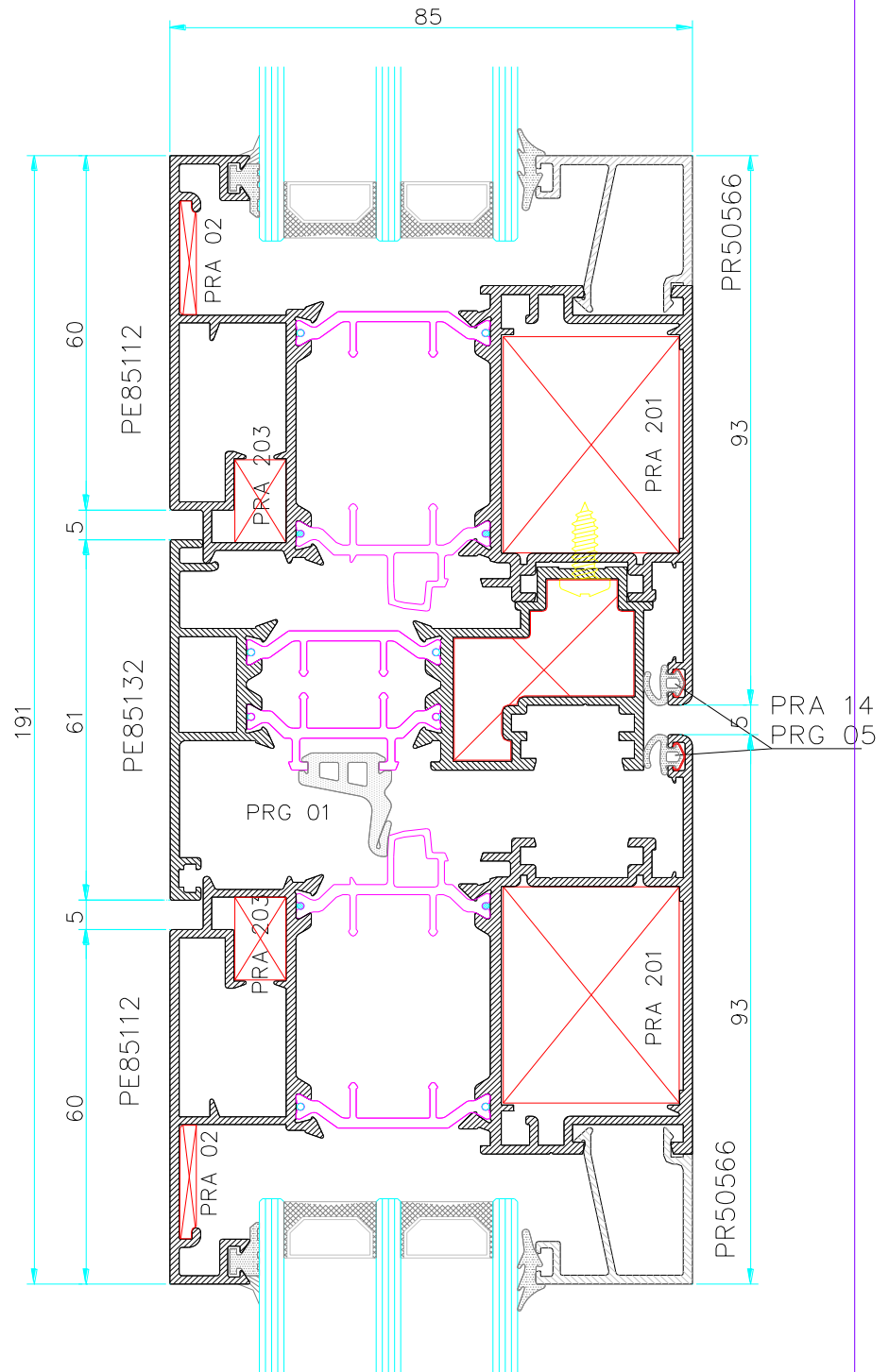
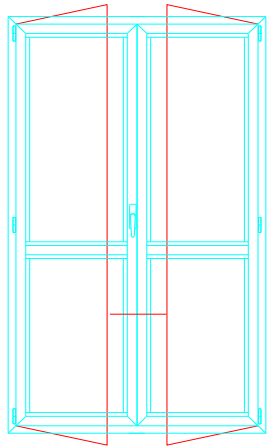

TIPIËNI PRESJECI

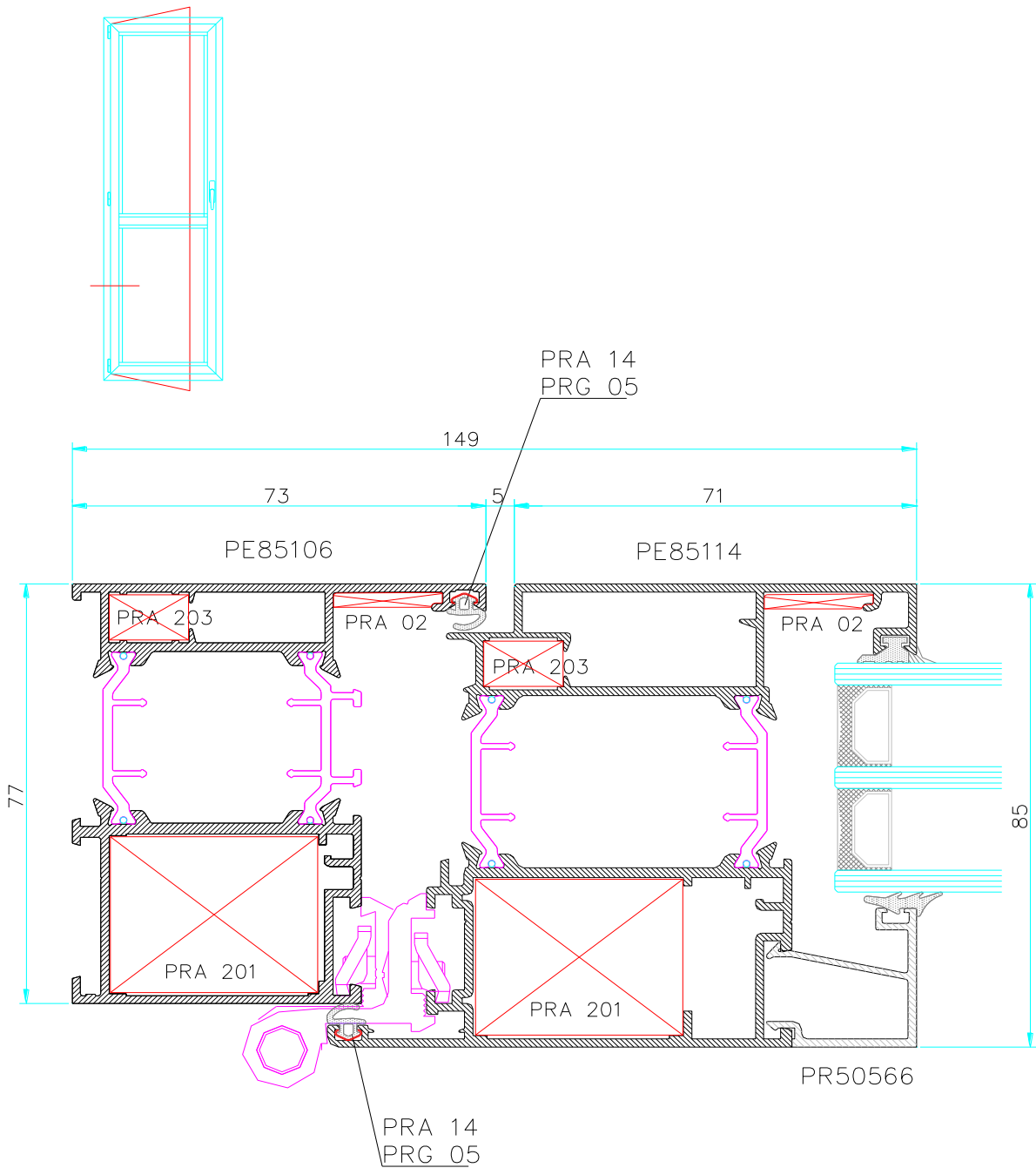

TIPIËNI PRESJECI

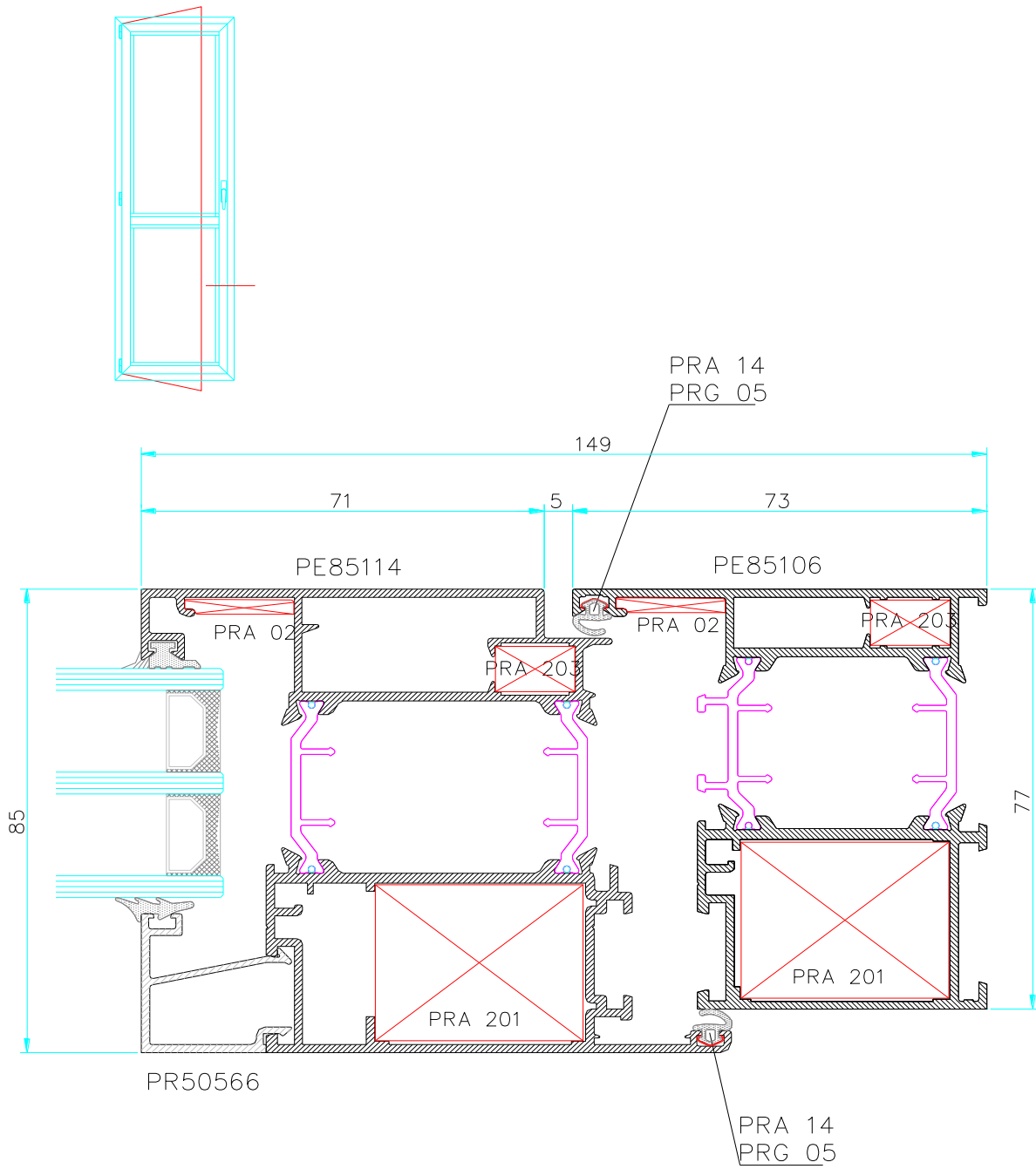

TIPIËNI PRESJECI

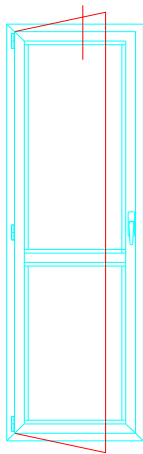

PRA 14
PRG 05

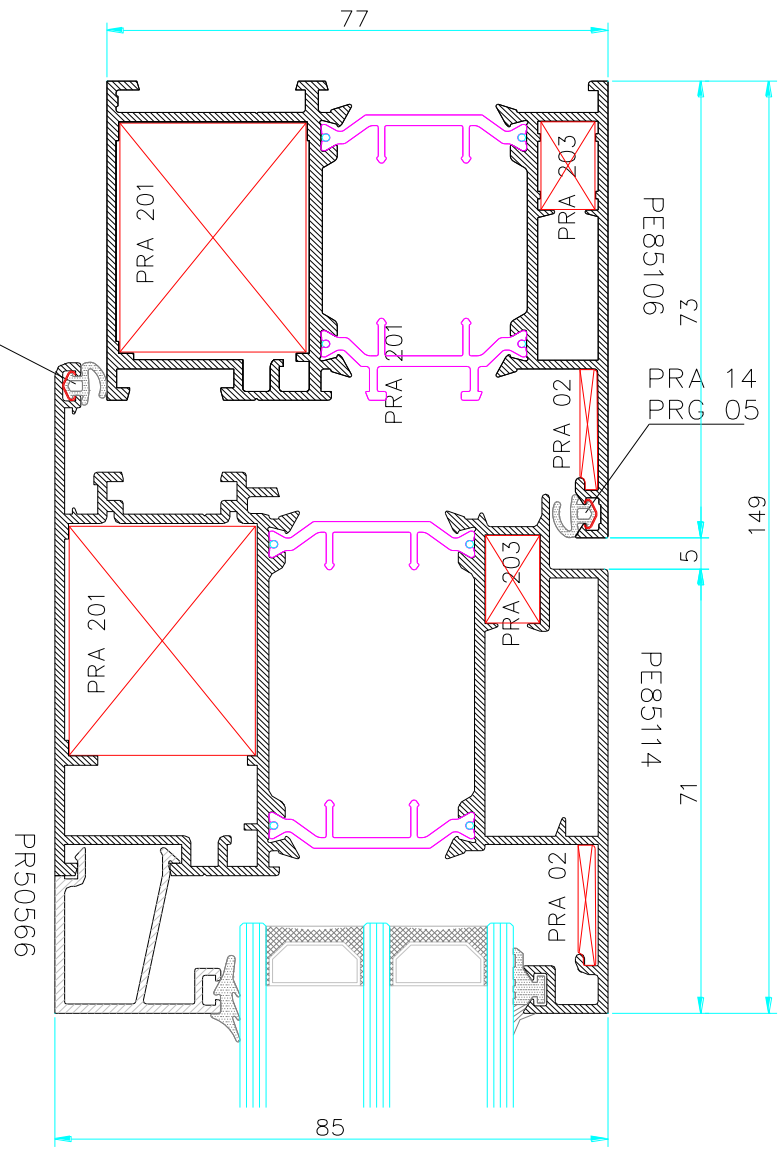

TIPIËNI PRESJECI

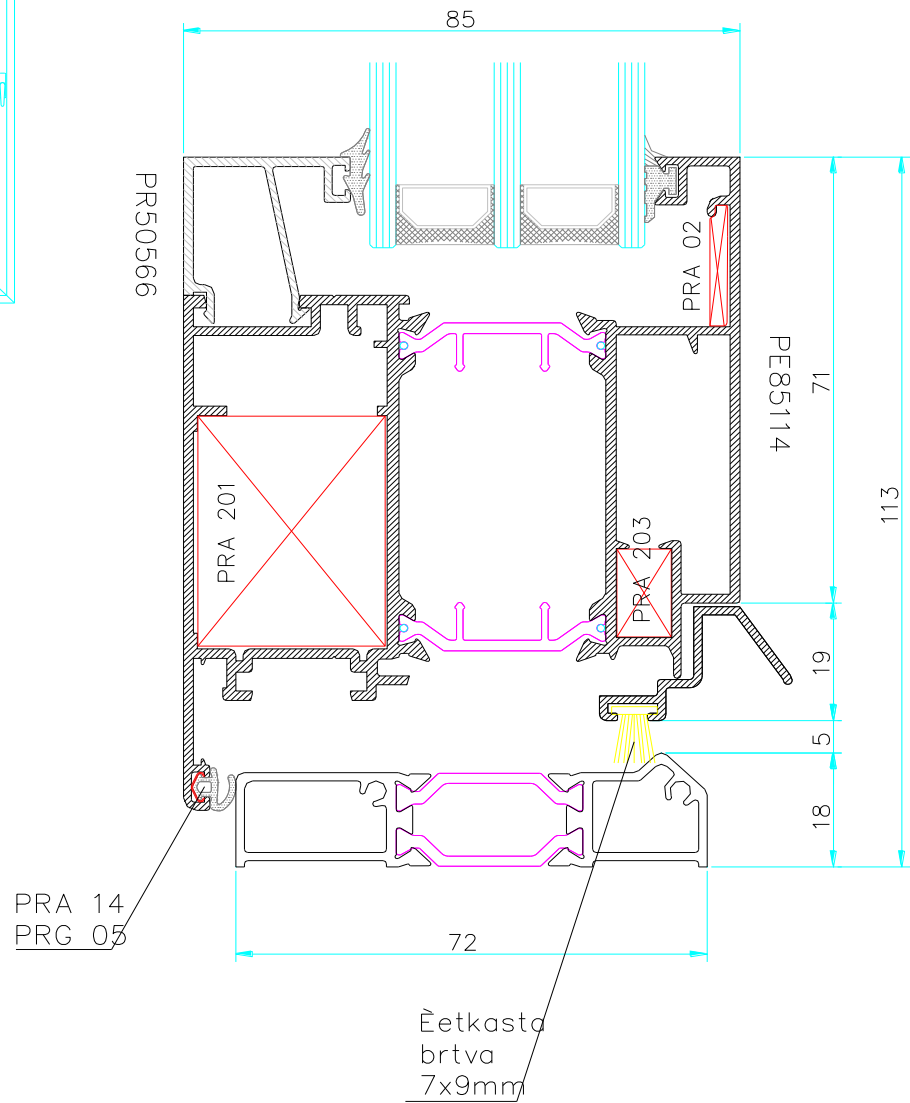
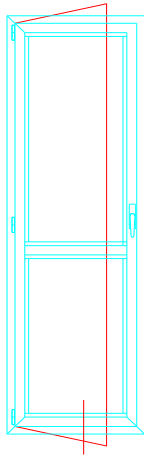

TIPIËNI PRESJECI

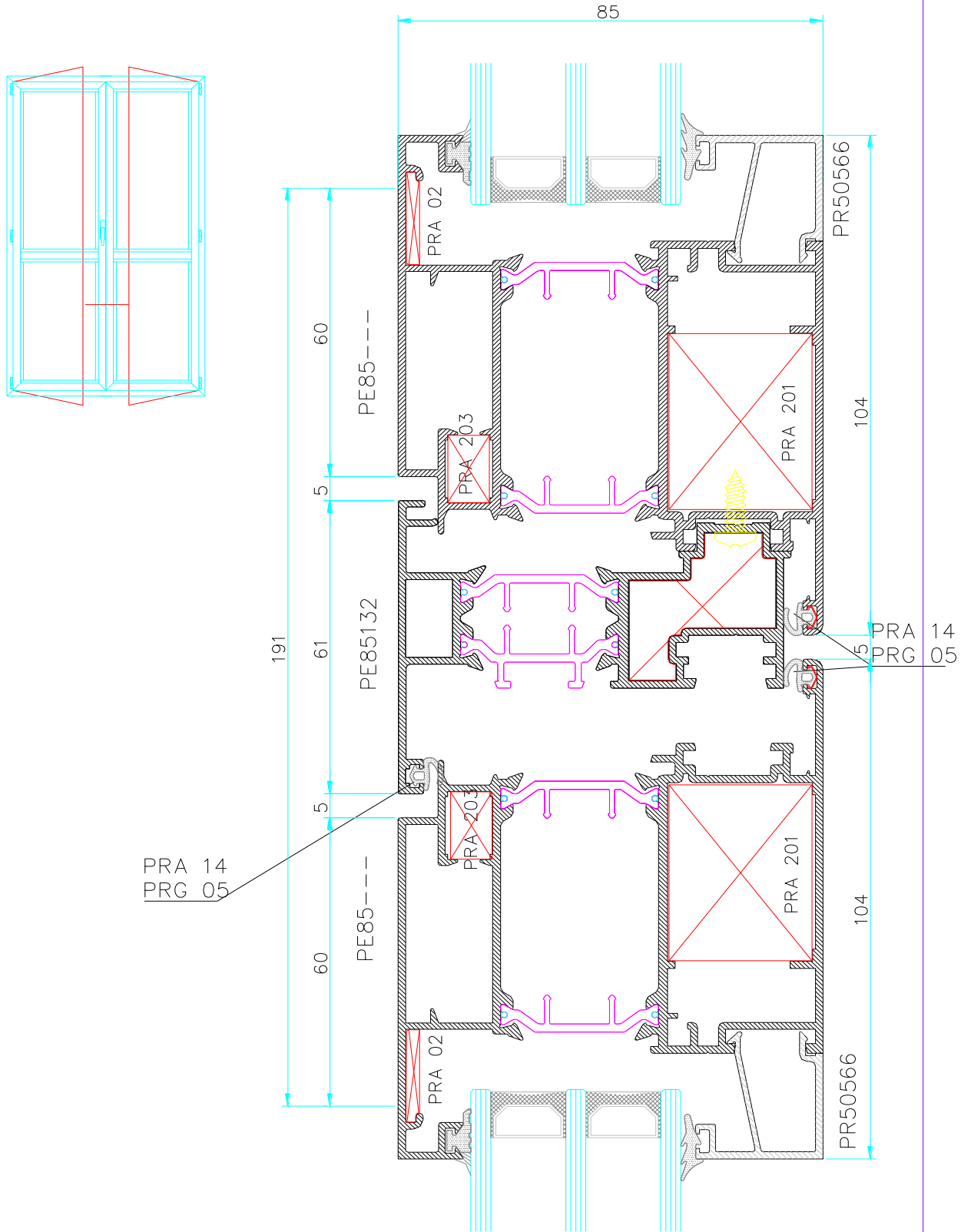

TIPIËNI PRESJECI

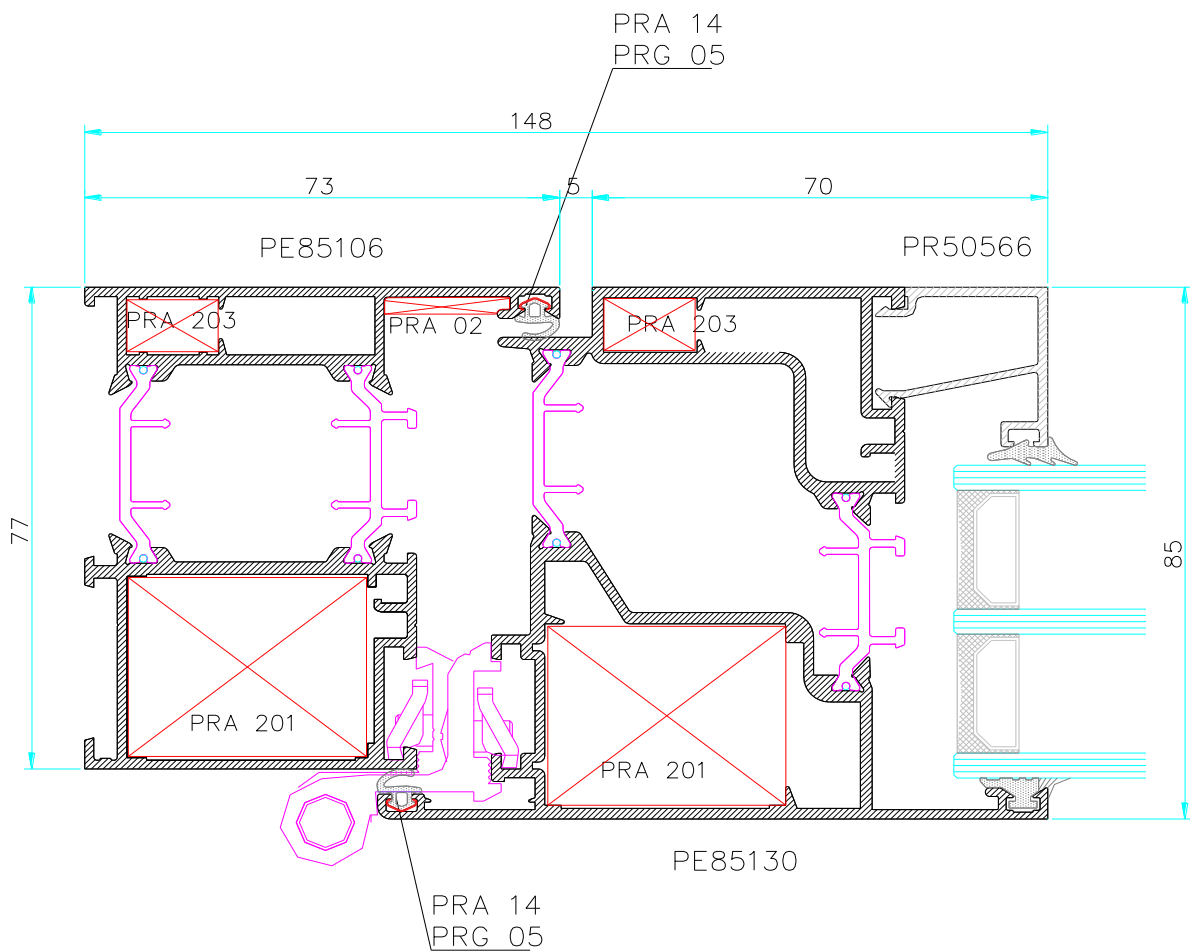
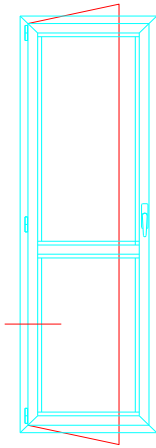

TIPIËNI PRESJECI

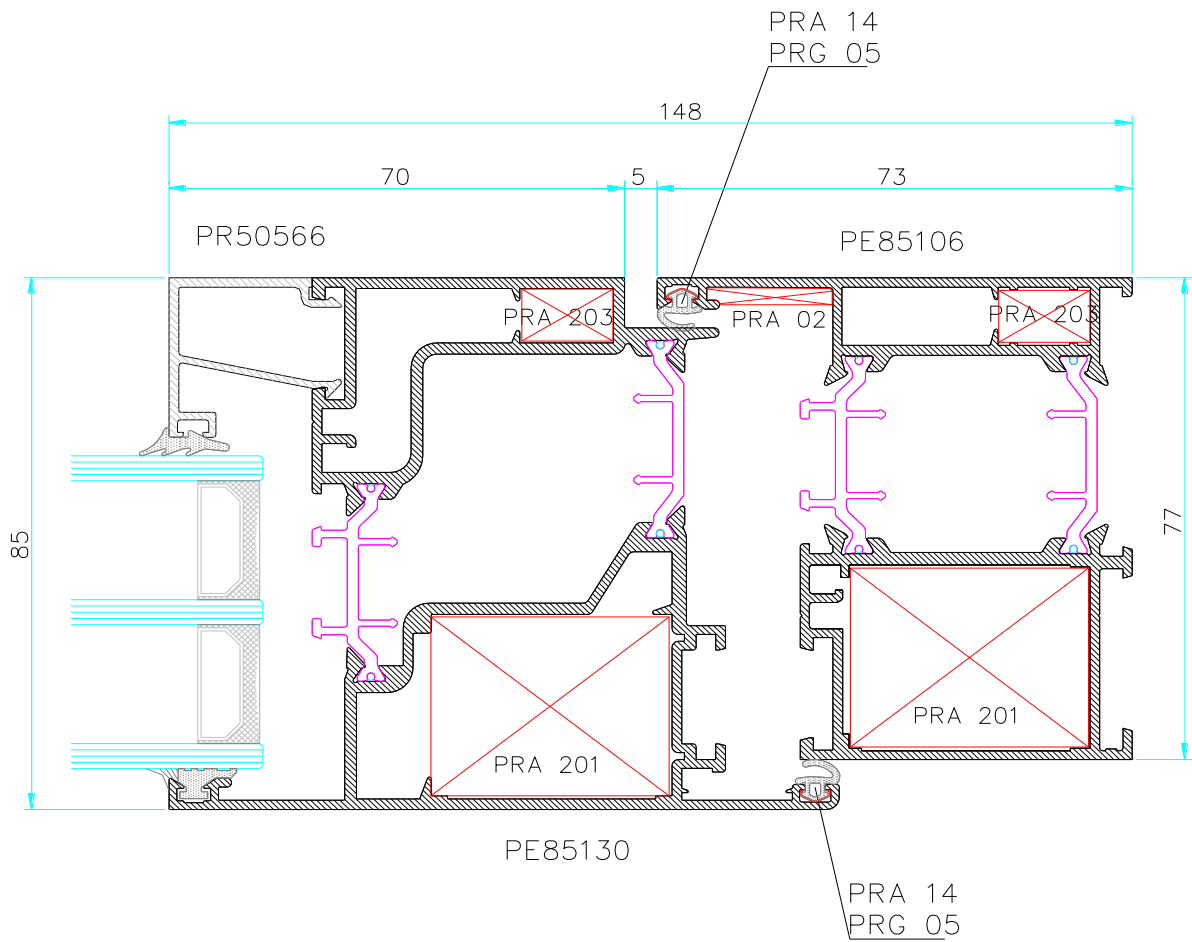
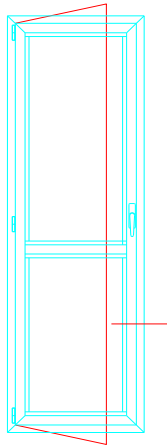

TIPIËNI PRESJECI

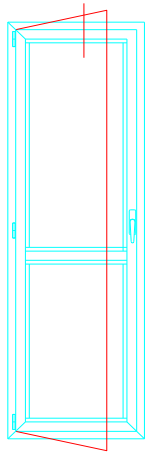

PRA 14
PRG 05

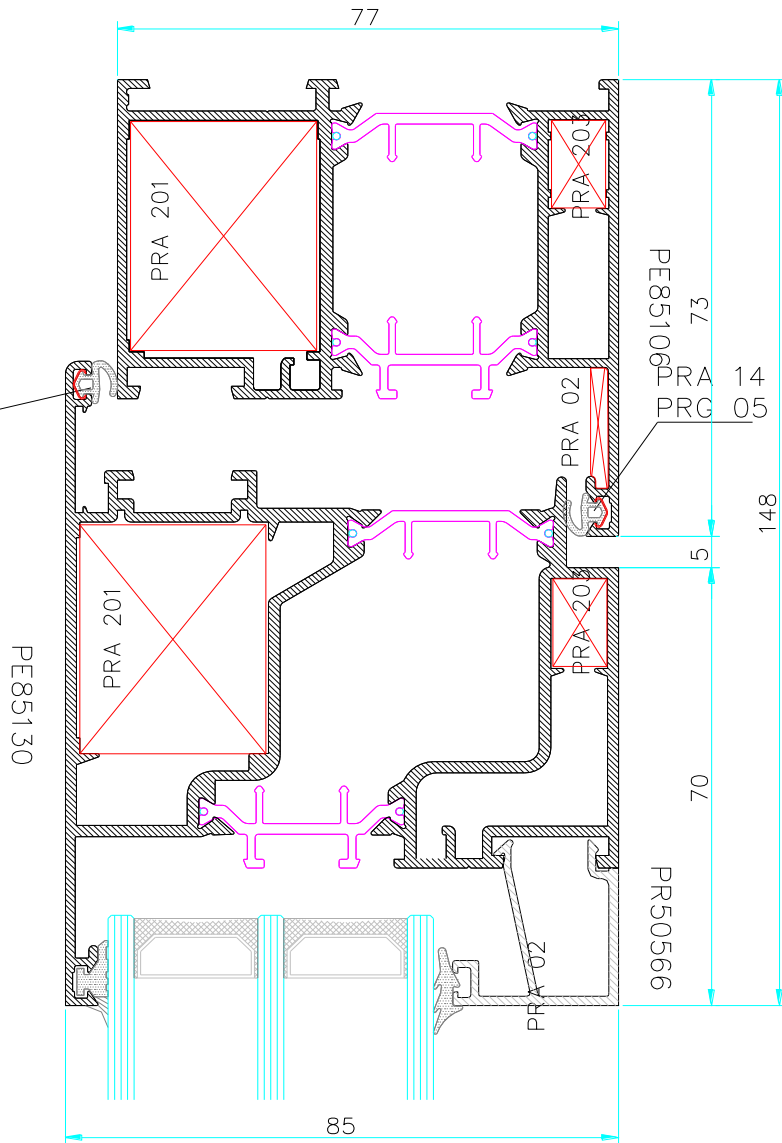

TIPIËNI PRESJECI

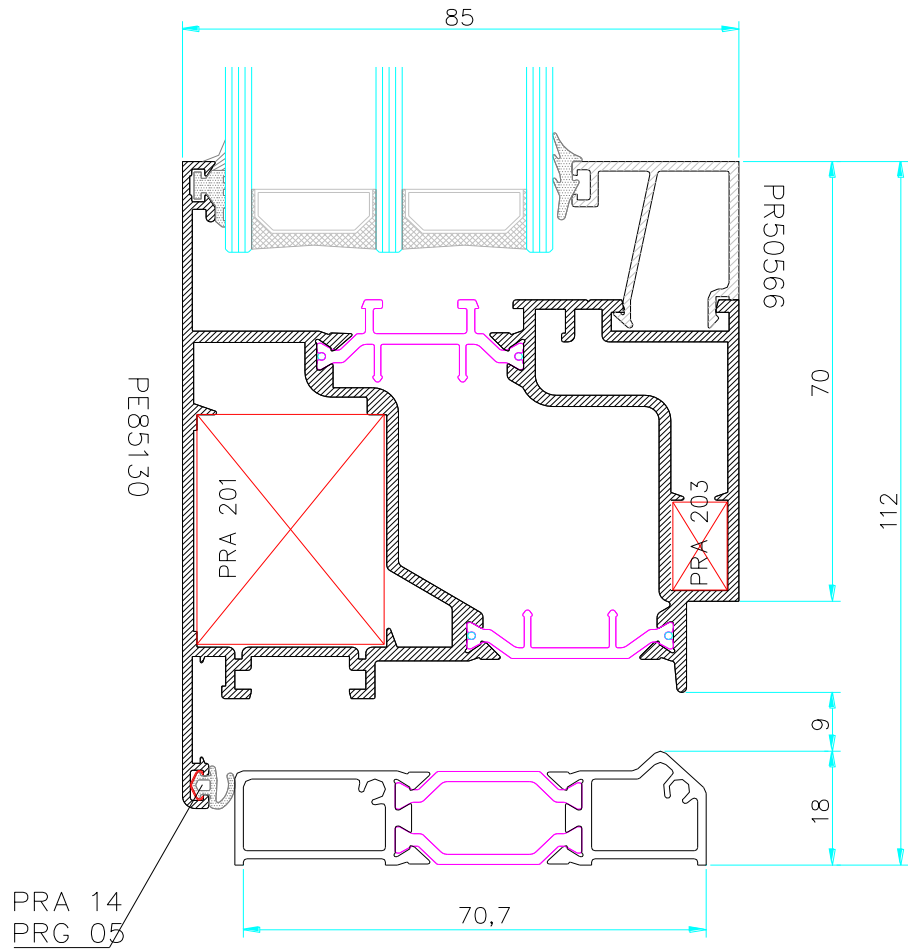
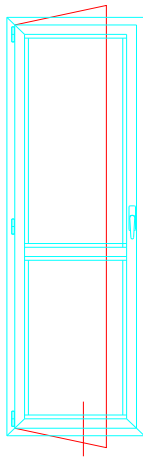

TIPIÈNI PRESJECI

